

Transmission chain

*Installation, maintenance
& designer guide*



RENOLD

Superior Chain Technology

Renold Chain Product Range



Roller Chain

- British, ANSI, API, DIN, ISO and Works Standard Chains
- Adapted Chains
- Extended Pitch Chains
- Hollow Pin Chains
- Made to Order, Special Chains
- Mini Pitch Chains
- Nickel Plated Chains
- Oilfield Chains
- Plastic Bush Chains
- Power and Free Chains
- Polymer Block Chains
- Side Bow Chains
- Stainless Steel Chains

Applications

- Abattoirs • Air Conditioning • Aircraft - Civil & Military • Bakery Machines • Battery Manufacturing
- Brewing • Canning • Carpet Machines • Chart Tables/Marine • Chocolate Manufacturing
- Concrete Moulding Equipment • Copying Machines • Dairy Machinery • Drying Machinery
- Earth Moving Equipment • Extrusion Machines • Filtration Plants • Food & Drink Manufacture
- Glass Manufacture • Health Care Equipment • Hydraulic Components • Ice-Cream Manufacture
- In-flight Refuelling • Ingot Casting & Scrap Metal Processing • Latex Machinery • Laundry Machinery
- Lawnmower Manufacture • Mill Machinery • Mining • MOT Brake Testing Machinery • Nuclear Power
- Off Road Vehicles • Oil Industry • Packaging Machines • Paper & Card Making • Paper Shredders
- Plastic Machinery • Potato Grading Machinery • Power Generation • Printing Machines • Quarry Plant
- Road Making & Plant Machinery • Robotic Systems • Roof Tile Manufacture • Ship's Engines
- Silkscreen Machinery • Ski-Lifts • Soot Blowers • Steel Making • Straddle Carriers • Sugar Beet Machines • Sun-Blinds • Telecommunications • Textile Machinery • Timber and Woodworking Machines
- Tin Printer Ovens • Tobacco/Cigarette Machinery • Tunnelling Machines • T.V. and Audio Equipment
- Tyre Manufacture • Waste Handling • X-Ray Equipment



Conveyor Chain

- British, ISO and Works Standard Chains
- Adapted Chains
- Agricultural Chains
- Bakery Chains
- Deep Link Chains
- Escalator Chains
- Made to Order, Specials
- Stainless Steel Chains
- Sugar Cane Chains
- Zinc Plated Chains

Applications

- Abattoirs • Agricultural Machines • Bakery Machines • Bottle Washing Plants
- Brick & Tile Machinery OEM • Car Plants • Cement Plants • Chemical Plants • Chicken Process Equipment • Cigarette/Tobacco Machinery • Dust Filters • Egg Sorting Conveyors • Electrical Switchgears • Escalators • Extrusion Machines • Feed Mill Machines • Feed Silo Equipment • Fibreglass Industry • Filtration Plants • Fish Conveyor • Food Sterilisation • Food Processing • Freezing Equipment • Freezing Tunnels • Glass Manufacturing • Grain Conveyor • Harvesting Machines • Ice Cream Machines • Induction Furnaces • Ingot Casting & Scrap Metal Processing Mfr • Latex Machinery • Leisure Rides • Luggage & Parcel Handling • Machine Tools • Mail Sorting • Metal Casting • Mushroom Compost Machinery • Nuclear • Ovens/Provers • Potato Grading Machinery • Potting Machinery • Quarries • Radio Astronomy • Roof Tile Manufacture • Rope Machinery • Saw Mill Equipment • Sewage Plants • Shaker Conveyors • Ski-Lifts • Sluice Gates • Steel Making • Sugar Factories • Swarf Conveyors • Textile Machinery • Timber & Woodworking Machines • Tool Changer • Tunnelling Machines • Tyre Manufacture • Washing & Sterilising Machines • Water Treatment • Wire Belts



Lifting Chain

- LH(BL), AL, LL and Works Standard Chains

Applications

- Bottle Washing Plants • Cement Plants • Chemical • Counterbalance Sets • Cranes
- Dust/Swarf Conveyors • Elevators • Food Processing • Food Sterilisation • Fork Lift Trucks
- Pipe Line Valves/Taps • Printing Machines • Rock Drilling • Straddle Carriers • Sun-Blinds • Tail Lifts

Table of Contents

Section 1 - Chain Installation and Maintenance

| | |
|-----------------------------|-------|
| Sprocket alignment | 6 |
| Installation / adjustment | 7 |
| Maintenance schedule | 8 |
| Lubrication, methods | 9 |
| Chain Wear, measurement | 10 |
| Length alterations | 11 |
| Pairing and Matching | 12 |
| Assembling Connecting Links | 13 |
| Troubleshooting | 14-16 |

Section 2 - Designer Guide

| | |
|-----------------------------------|-------|
| Chain History | 18 |
| Chain Performance | 19 |
| Wear Factors | 20 |
| International Standards | 21 |
| International Standards | 22 |
| Chain drive advantages | 23 |
| Chain Selection | 24 |
| Sprocket and Chain Compatibility | 25 |
| Drive layout | 26 |
| Selection Methodology | 27 |
| Sprocket Materials | 28 |
| Ratings Charts - European (BS) | 31 |
| Ratings Charts - ANSI | 32 |
| Chain Suspension Force | 33 |
| Lifting Applications | 34 |
| Bush, Roller and ANSI Xtra chains | 35 |
| Factors of Safety | 36 |
| Chain Matching | 37 |
| Repair and Adjustment | 38 |
| Design Ideas / PCD Factors | 39 |
| Drive Design Examples | 40-42 |
| Shafts in Parallel | 43 |

Section 1

Chain Installation & Maintenance



WARNING

HEALTH AND SAFETY WARNING

The following precautions must be taken before disconnecting and removing a chain from a system prior to replacement.

1. Always isolate the power source from the drive or equipment.
2. Always wear safety glasses.
3. Always wear appropriate protective clothing, hats, gloves and safety shoes as warranted by the circumstances.
4. Always ensure tools are in good working condition and used in the proper manner.
5. Always loosen tensioning devices.
6. Always support the chain to avoid sudden unexpected movement of chain or components.
7. Never attempt to disconnect or reconnect a chain unless the chain construction is fully understood.
8. Always ensure that directions for the correct use of any tools are followed.
9. Never reuse individual components.
10. Never reuse a damaged chain or chain part.

N.B. Breach of these practices could result in serious injury or death.

Chain Installation and Maintenance

Introduction

Renold Chain has over 120 years' experience in the operation and maintenance of transmission chain. Involvement with designers, manufacturers and users of all types of equipment has enabled Renold to develop this definitive guide, designed to pass on the preferred methods of correct handling, adjustment, installation and maintenance of transmission chain drives resulting in maximum chain life.

Should you require any further information, please contact our technical sales staff.

Equipment Needed

The breaking of chain can be achieved by using a Renold Chain Extractor, these being:-

- 311015 for light industrial chains up to 0.5" pitch.
- 10101 for chains from 0.375" to 0.625" pitch
- 10102 for chains from 0.75" to 1.25" pitch

For joining any chain up to 2.5" pitch, a drift punch will be required.

Erection of medium or heavy chain drives requires millwrighting equipment such as lifting tackle, slings, wedges, packing, etc.

Other useful equipment

Quantity of inner and outer links.

Straight edges and/or strong, fine line.

Spirit level.

Plumb line.

Selection of hammers, files, key blanks, etc.

Preparation

Check equipment to ensure that general transmission requirements are correct (e.g. flexible couplings, flywheel, means of drive adjustment).

Check condition and rigidity of the shafts and bearings, particularly if there has been considerable previous service with an alternative method of transmission. Replace or rectify if necessary.

Driver and driven shafts should be checked to ensure they are level and parallel to each other. This applies equally to the jockey shaft if present.

Use a spirit level and adjustable comparator bar or micrometer between shafts at extreme points on each side of the drive. Rectify any parallelism error present and mark a permanent datum line for the adjustable shaft.

Place sprockets or respective shafts in approximate alignment and fit the keys in accordance with correct engineering practice. Do not finally secure keys at this stage.

Care must be taken with sprockets of split design to ensure perfect abutting of the faces of each half. Proceed with the key fitting after the halves are finally bolted together, otherwise the key can prevent correct assembly and subsequently result in malgearing.

It should be verified that key heads will not project beyond the width of any chaincases.

Checking Sprocket Alignment

Accurate alignment of shafts and sprocket tooth faces provides a uniform distribution of load across the entire chain width and contributes substantially to maximum drive life.

Use a straight edge across the machined faces of the sprockets in several different positions, if possible, as a check against wobble. A nylon or similar line is a good substitute for a straight edge particularly on longer centre distances.

Should endwise "float" of shafts be present, make due allowance so that sprocket alignment is correct at the mid position of "float".

When alignment is correct within closest practical limits, drive the keys home and take a final check on sprocket alignment.

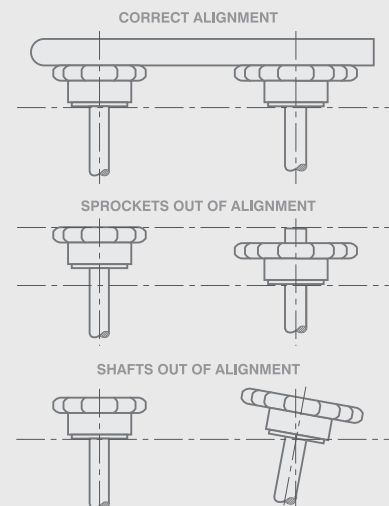

Chain Installation and Maintenance

Important Note

Sprockets should always be designed to be as close to the supporting bearings as possible.

Installation of Chain

Renold Chain should not be assembled on the sprockets until attention has been paid to:

1. Cleanliness of the sprocket teeth, particularly if debris of an abrasive nature (cement dust, weld spatter, etc.), has been prevalent whilst work was in progress.
2. Temporary positioning of the lower section of a chaincase if present. In restricted spaces, manoeuvring of large sections is often simplified by using the spaces between shafts which will later be occupied by the chain.

Ensure the chain is clean and free from debris and place around the sprockets, observing instructions where matched strands are involved. In chain of two or more strands, joining is most easily accomplished at the mid span of the drive, drawing the chain ends together with a chain clamp or rope tackle block. Ensure that the strength of the drawing tackle is sufficient to hold the chain. Chain weights are shown in the Renold catalogue. When inserting the joining link of multiplex chain, ensure the intermediate plates are assembled. Do not detach the drawing tackle until the link is completely assembled. When only partially inserted through inner links, the

weight of the chain on release can “splay” unsupported bearing pins.

Adjust the chain using the datum mark mentioned in the preparation section to retain shaft parallelism.

For a chain of average centre distance (30-50 x chain pitch) correct adjustment is when the mid point of the longest span can be fully moved by hand in accordance with dimension 'A' shown in diagram one.

Chaincases

- Position the chaincase bottom sections with the shafts concentric in their cavities
- Manufacture suitable mountings and brackets to ensure rigidity
- Assemble the oil supply and return pipe system and the drive to the oil pump
- Assemble top section(s) of chaincase
- Fill the oil sump and check delivery to the chain

Chain Adjustment

To maximise chain life, some form of chain length adjustment must be provided, preferably by moving one of the shafts. See diagram three. If shaft movement is not possible, an adjustable jockey sprocket engaging with the unloaded strand of the chain is recommended. Generally, the jockey should have the same number of teeth as the driver sprocket and care should be taken to ensure speed does not exceed the maximum ratings shown.

The chain should be adjusted regularly so that with one strand tight the slack strand can be moved a distance of 'A' at the mid point. See diagram one, on this page.

To cater for any eccentricities of mounting, the adjustment of the chain should be tried through a complete revolution of the large sprocket.

Adjustment, as shown in these diagrams, is achieved either by the movement of one of the shafts or by use of the jockey sprocket. The amount of the adjustment provided by either method should be sufficient to take up chain wear amounting to two pitches or two percent elongation above nominal chain length, whichever is the smaller.

Diagram two

When used for adjustment, a jockey should be positioned on the unloaded side of the chain, preferably nearer to the driven sprocket and gearing with the outside of the chain; it should have an initial chain lap of at least three teeth and a free length of chain not less than four pitches between it and the nearest sprocket. See diagram two above.

Generally, the number of teeth in any jockey should not be less than the smallest sprocket and care should be taken to ensure that the speed does not exceed the maximum recommended. Where necessary, several sprockets can be used on a single drive, thereby meeting all possible needs for adjustment.

Diagram one

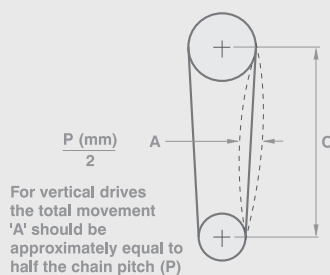

A = Total movement
C = Horizontal centre distance

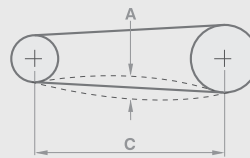

$$\text{Total movement 'A' (mm)} = \frac{C \text{ (mm)}}{K}$$

Where K = 25 for smooth drives
= 50 for shock drives

Over-tensioning should be avoided in all cases.

Diagram two

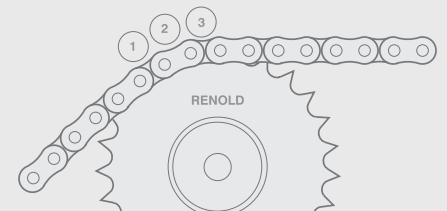

Chain Installation and Maintenance

All mountings for jockeys should be rigid and when manual adjustment is provided, the moving member must be securely locked in position after adjustments have been made.

Automatic adjustment

Automatic adjustment can also be provided, but this adjustment generally demands a special study of the conditions to enable a suitable design to be provided.

Test Run

It is advisable to give the drive a short test run for the following reasons:

1. To regulate oil delivery to the chain.
2. To eliminate any oil weeps from the chain case and pipework.
3. To check for any unusual noise or vibration.

Maintenance Schedule

Regular chain maintenance is important if maximum life is to be achieved. In a correctly sized and installed drive the chain can be expected to last for approximately 15,000 hours.

The following maintenance schedule is suggested.

After 3 months

- Check chain adjustment and rectify if necessary
- Change oil, oil filter and clear the sump

Annually

- Carry out the above checks
- Check for wear on side plates
- Check for chain elongation
- Check cleanliness of components
 - Remove any accumulation of dirt or foreign materials
- Check for shaft and sprocket alignment
- Check for wear on sprockets
- Check the condition of the lubricant
 - Feed pipes are not clogged
 - Lubrication schedule is being followed (manual lubrication)
 - Drip rate is sufficient (drip system)
 - Oil level is correct (drip, bath and disc systems)
 - Pump is working (stream system)

Chain Protection

A new Renold chain should always be stored in its box and/or bag until installation. Renold chain is lubricated at the factory, but this lubrication will not stand up to outdoor conditions, particularly where there is a salt water atmosphere.

Unprotected, lubricated chains will become contaminated with grit and other materials which will harm the chain and tend to clog strainers, filters and oil lines. A roller chain is a precision made series of bearings that will perform best if handled and stored in correct conditions.

Diagram three

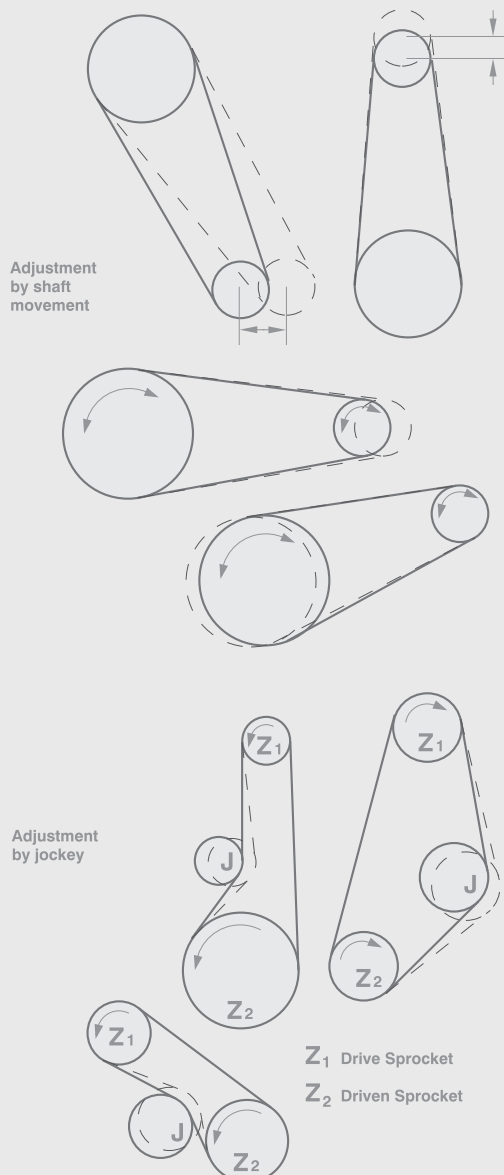

Chain Installation and Maintenance

Lubrication

Renold chain drives should be protected against dirt and moisture and be lubricated with good quality, non-detergent petroleum based oil. A periodic change of oil is desirable as already outlined. Heavy oils and greases are generally too stiff to enter the chain working surfaces and should not be used.

Care must be taken to ensure that the lubricant reaches the bearing area of the chain. This can be done by directing the oil into the clearances between the inner and outer link plates, preferably at the point where the chain enters the sprocket on the bottom strand.

The table below indicates the correct lubricant viscosity for various ambient temperatures.

| Ambient Temperature Celsius | Lubricant SAE | Rating BS4231 |
|-----------------------------|---------------|---------------|
| -5 to +5 | 20 | 46 to 68 |
| 5 to 40 | 30 | 100 |
| 40 to 50 | 40 | 150 to 220 |
| 50 to 60 | 50 | 320 |

For the majority of applications in the above temperature range, a multigrade SAE 20/50 oil would be suitable.

Use of grease

As mentioned above, the use of grease is not recommended. However, if grease lubrication is essential the following points should be noted:

- Limit chain speed to 4 metre/sec.
- Applying normal greases to the outside surfaces of a chain only seals the bearing surfaces and will not work into them. This causes premature failure. Grease has to be heated until fluid and the chain are immersed and allowed to soak until all air bubbles cease to rise. If this system is used the chains need regular cleaning and regreasing at intervals, depending on the drives, power and speed.

Abnormal ambient temperatures

For elevated temperatures up to 250°C, dry lubricants such as colloidal graphite or MoS₂ in white spirit or poly-alkaline glycol carriers are most suitable.

Conversely, at low temperatures between -5° and -40°C, special low temperature initial greases and subsequent oil lubricants are necessary. Lubricant suppliers will give recommendations.

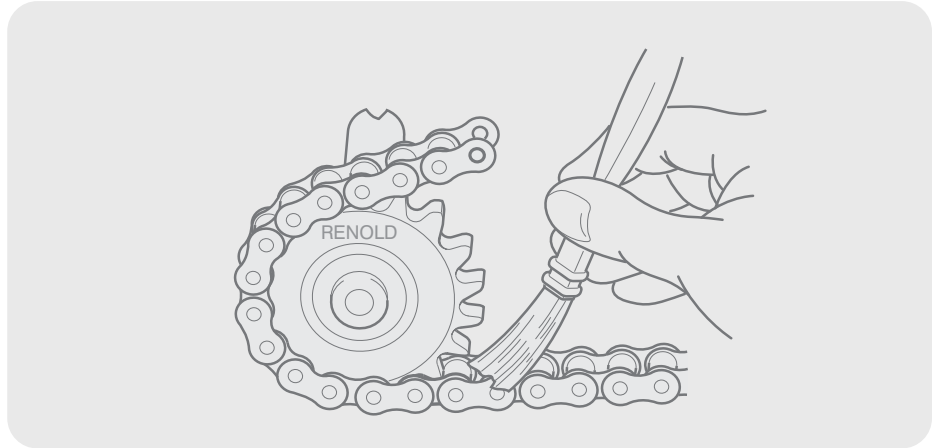

Lubricating methods

There are four basic methods for lubricating chain drives. The recommended methods are shown in the rating charts which are determined by the chain speed and power transmitted.

Type 1, Manual Lubrication

Oil is applied periodically with a brush or oil can, preferably once every 8 hours of operation. Volume and frequency should be sufficient to just keep the chain wet with oil and allow penetration of clean lubricant into the chain joints.

Applying lubricant by aerosol can be satisfactory under some conditions, but it is important that the aerosol lubricant is of an approved type for the application, such as that supplied by Renold. This type of lubricant penetrates into the pin/bush/roller clearances, resisting both the tendency to drip or drain when the chain is stationary and centrifugal “flinging” when the chain is moving.

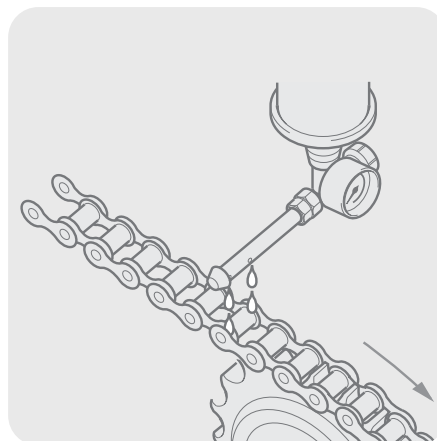

Type 2, Drip Lubrication

Oil drips are directed between the link plate edges from a drip lubricator. Volume and frequency should be sufficient to allow penetration of lubricant into the chain joints.

Type 3, Bath or Disc Lubrication

With oil bath lubrication, the lower strand of chain runs through a sump of oil in the drive housing. The oil level should cover the chain at its lowest point during operation.

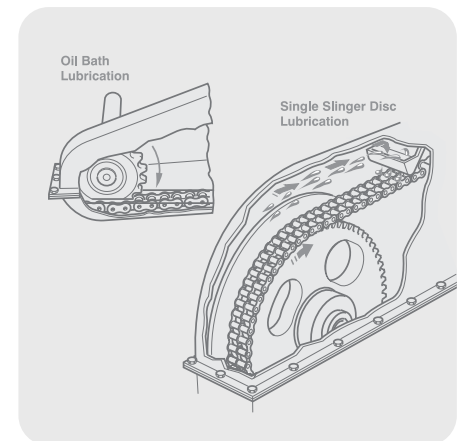

Chain Installation and Maintenance

With slinger disc lubrication, an oil bath is used but the chain operates above the oil level. A disc picks up oil from the sump and deposits it on the chain by means of deflection plates. When such discs are employed they should be designed to have peripheral speeds between 180 to 2240 metre/min.

Type 4, Stream Lubrication

A continuous supply of oil from a circulating pump or central lubricating system is directed onto the chain. It is important to ensure that the spray holes from which the oil emerges are in line with the chain edges. The spray pipe should be positioned so that the oil is delivered onto the chain just before it engages with the driver sprocket.

This ensures that the lubricant is centrifuged through the chain and assists in cushioning roller impact on the sprocket teeth. Stream lubrication also provides effective cooling and impact damping at high speeds. It is, therefore, important that the method of lubrication specified is closely followed.

Effect of temperature

During operation an important factor to control in a drive system is the chain and chaincase temperature. Depending on the severity of the drive service, continuity of use, etc., special attention to the lubrication method may be required.

Chain temperatures above 100°C should be avoided if possible due to lubricant limitations, although chain can generally give acceptable performance up to around 250°C in some circumstances. A way of improving the effectiveness of the lubrication and its cooling effect is to increase the oil volume (up to 4.5 litres per minute per chain strand) and incorporate a method of external cooling for the oil.

To Measure Chain Wear

A direct measure of chain wear is the extension in excess of the nominal length of the chain and the chain wear can, therefore, be ascertained by length measurement in line with the instructions given below.

- Lay the chain, which should terminate at both ends with an inner link (part No. 4), on a flat surface and, after anchoring it at one end, attach to the other end a turnbuckle and a spring balance suitably anchored.
- Apply a tension load by means of the turnbuckle amounting to:

For simple chain: $P^2 \times 0,77$ Newtons

For duplex chain: $P^2 \times 1,56$ Newtons

For triplex chain: $P^2 \times 2,33$ Newtons

Where P is the pitch in mm.

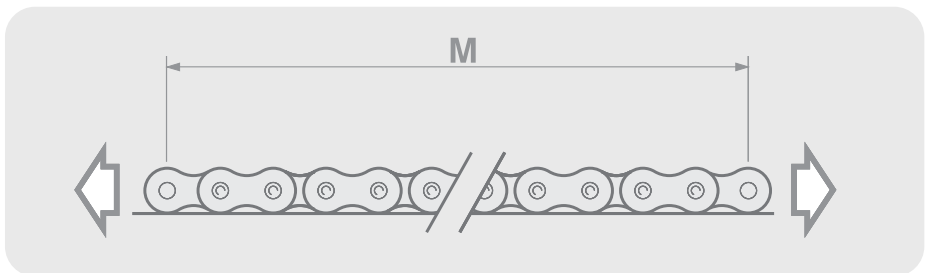
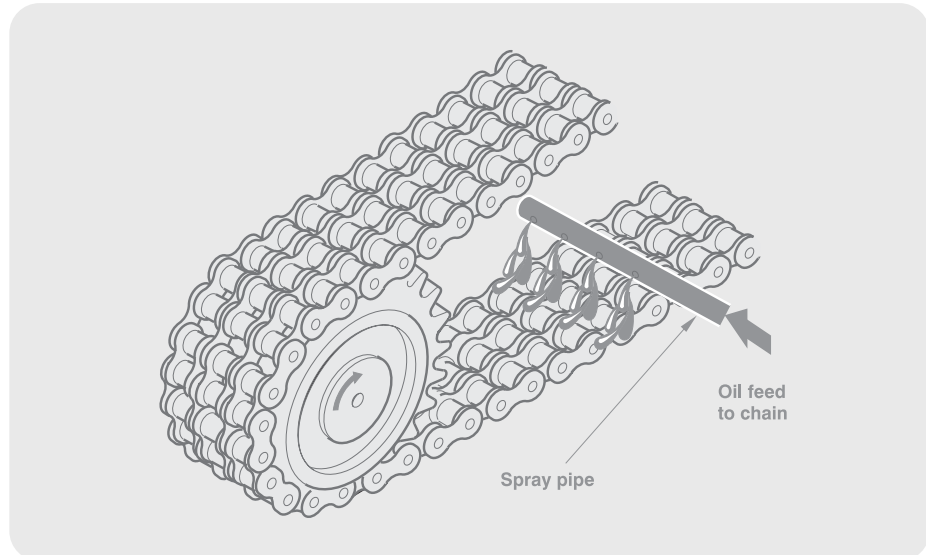

In the case of extended pitch chains (e.g. chains having the same breaking load and twice the pitch) apply a measuring load as for the equivalent short pitch chains.

As an alternative to the use of a turnbuckle and spring balance, the chain may be hung vertically and the equivalent weight attached to the lower end.

- Measure length 'M' (see diagram) in millimetres from which the percentage extension can be obtained from the following formula:

$$\text{Percentage extension} = \frac{M - (X \times P)}{X \times P} \times 100$$

Where X = number of pitches measured
P = pitch in mm

- As a general rule, the useful life of the chain is terminated and the chain should be replaced when the percentage extension reaches 2 per cent (1 per cent in the case of extended pitch chains). For drives with no provision for adjustment, the rejection limit is lower, dependent upon the speed and layout. A usual figure is between 0.7 and 1.0 per cent extension.

Renold chain wear guide

A simple to use chain wear guide is available from Renold Chain for most popular sizes of chain pitch. Please contact your sales office for details.

Riveting Chain Endless

Roller chain up to 63.5mm (2.5") pitch

- Insert the bearing pins of the outer link (No. 107) through the inner links of the chain to be joined. If multiplex chain, assemble intermediate plates at the same time.
- Provide support for the outer link (No. 107) while assembling the separate outer plate. This has a force fit and is driven onto the bearing pins using a hollow punch alternatively on each pin. Drive up to the shoulder on the shouldered bearing pins. Where there is no shoulder the plate is driven to the point of similar clearance between outer and inner links as with the adjacent chain.

Chain Installation and Maintenance

- Still supporting the outer link (No. 107), rivet the bearing pin ends, taking care to finish with a neat uniform spread having a similar appearance to the machine riveted pins in the adjacent chain. The force required to spread the pin end will vary with the pitch of the chain; excessive riveting force should always be avoided. Except where final chain joining in-situ is necessary, the work should be carried out on a bench.
- Check that the newly fitted link articulates freely in the adjacent inner links.

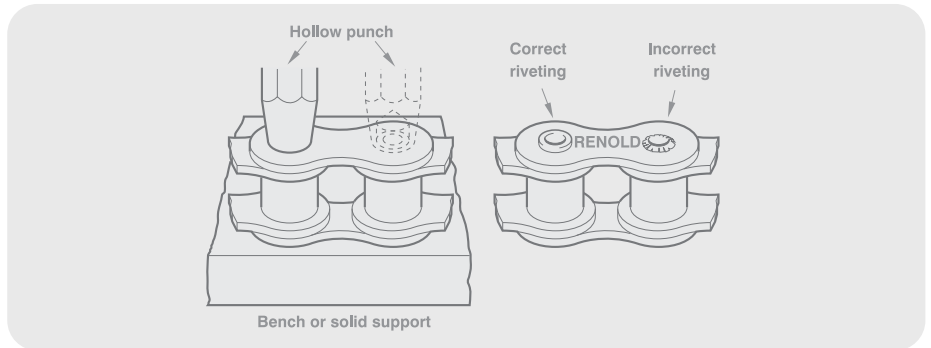

Chain length alterations

All drives should be designed wherever possible, with sufficient overall adjustment to ensure the use of an even number of pitches throughout the useful life of the chain. Cranked links should never be used on impulsive, highly loaded or high speed chain drives.

In less arduous conditions where there is no other solution and the use of a cranked link is unavoidable, the diagrams show how length alteration can be accomplished.

A chain having an even number of links requires the incorporation of a cranked link to effect an alteration of one pitch.

Chain having an odd number of links incorporates a cranked link which must be removed to effect an alteration of one pitch.

By removing the parts shown in dark shading and substituting those in light shading a chain can be shortened or lengthened by one pitch.

No joint which relies on a press fit for assembly should be reused after removal. A new joint should always be employed.

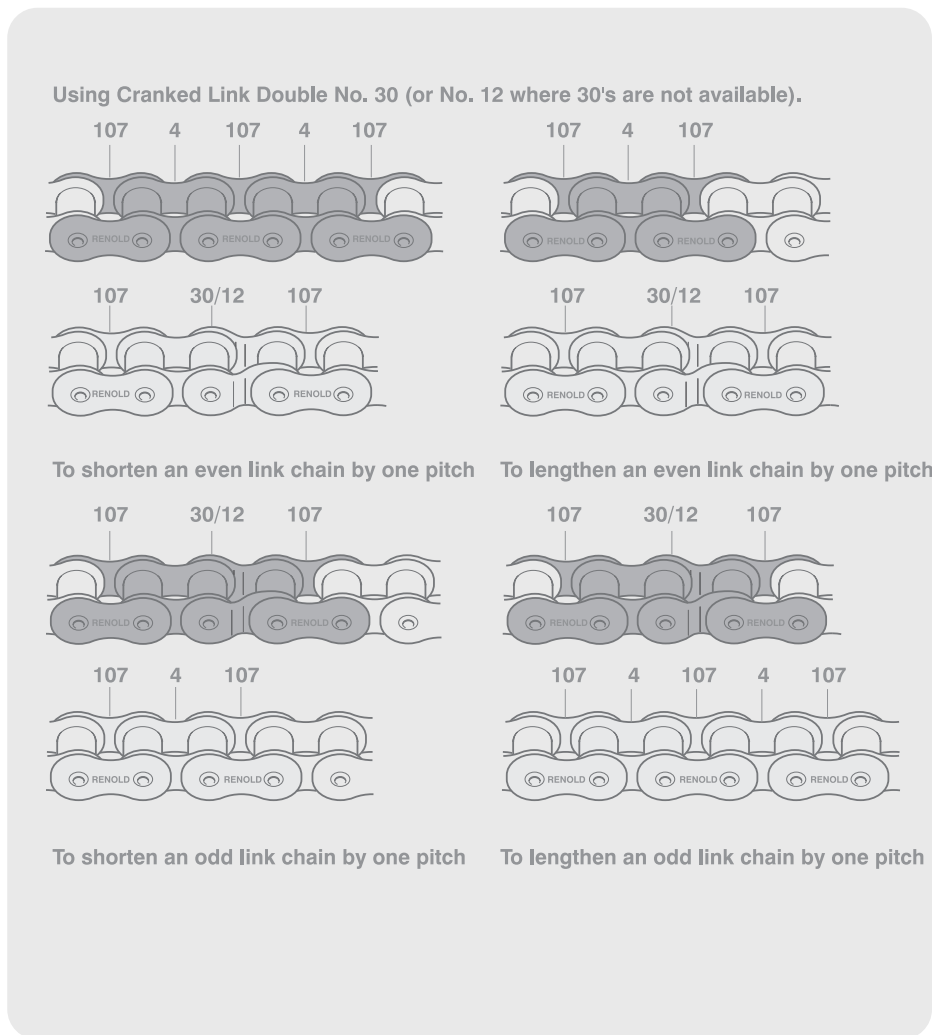

Chain Installation and Maintenance

Pairing and Matching Chains

Any application in which two or more strands of transmission chain are required to operate side by side in a common drive or conveying arrangement, may involve the need for either pairing or matching, and such applications generally fall into one of the following categories:

Length Matching for Conveying and Similar Applications

Wherever length matching of transmission chain is necessary it is dealt with as follows:

- The chains are accurately measured in handling lengths between 3m to 8m as appropriate and then selected to provide a two (or more) strand drive having overall length uniformity within close limits. However, such length uniformity will not necessarily apply to any intermediate sections along the chains, but the actual length of all intermediate sections, both along and across the drive, will not vary more than our normal manufacturing limits. However, adapted transmission chains are usually manufactured to specific orders which are generally completed in one production run so that it is reasonable to assume that length differences of intermediate sections will be small.
- Chains are supplied in sets which are uniform in overall length within reasonably fine limits and will be within our normal manufacturing limits. It should be noted that chain sets supplied against different orders at different times may not have exactly the same lengths to those supplied originally, but will vary by no more than our normal tolerance of 0.0%, +0.15%.

Pitch Matching Transmission Drive Chains

Pitch matched chains are built up from shorter subsections (usually 300 to 600mm lengths) which are first measured and then graded for length. All subsections in each grade are of closely similar length and those forming any one group across the set of chains are selected from the same length grade.

The requisite number of groups are then connected to form a pitch matched set of chains, or alternatively, if this is too long for convenient handling, a set of handling sections for customer to assemble as a final set of pitch matched chain. Suitable tags are fixed to the chains to ensure they are connected together in the correct sequence.

Identification of Handling Lengths

| | Handling Length 1 | Handling Length 2 | Handling Length 3 |
|----------|-------------------|-------------------|-------------------|
| A Strand | A-A1 | A1-A2 | A2-A3 |
| B Strand | B-B1 | B1-B2 | B2-B3 |
| C Strand | C-C1 | C1-C2 | C2-C3 |

Long chains are made up in sections, each section being numbered on end links. Sections should be so joined up that end links with similar numbers are connected. Where chains are to run in sets of two or more strands, each strand is stamped on end links of each section with a letter, in addition to being numbered. Correct consecutive sections for each strand must be identified from the end links and joined up as indicated.

By these means, the actual length of any intermediate portion of one strand (as measured from any one pitch point to any other) will correspond closely with that of the transversely equivalent portion on the other strands, generally within 0.05mm, depending on the chain pitch size.

Pitch Matching Adapted Transmission Chains

(when attachments are fitted to chains)

With the sole exception of extended bearing pins, it is not possible to match the pitch of holes in attachments themselves to within very fine limits, due to the additional tolerances to be contended with (bending, holing, etc.).

Colour Coding

For customers who wish to match their chains, perhaps in order to fit special attachments in situ, Renold colour code short lengths of chain within specified tolerance bands. These will normally be RED, YELLOW or GREEN paint marks to indicate lower, mid and upper thirds of the tolerance band. For even finer tolerance bands additional colours can be used, but normally a maximum of five colours will be more than adequate.

| COLOUR | | |
|--------|---|----------------------|
| RED | | 0.05% |
| YELLOW | | 0.10% |
| GREEN | | 0.15% |
| BLUE | } | For Finer Tolerances |
| WHITE | | |

Repair and Replacement

Sprockets

Examination of the tooth faces will give an indication of the amount of wear which has occurred. Under normal circumstances this will be evident as a polished worn strip about the pitch circle diameter on each of the sprocket teeth as shown on the diagram below.

If the depth of this wear 'X' has reached an amount equal to 10% of the 'Y' dimension, then steps should be taken to replace the sprocket. Running new chain on sprockets having this amount of tooth wear will cause rapid chain wear.

It should be noted that in normal operating conditions, with correct lubrication the amount of wear 'X' will not occur until several chains have been used.

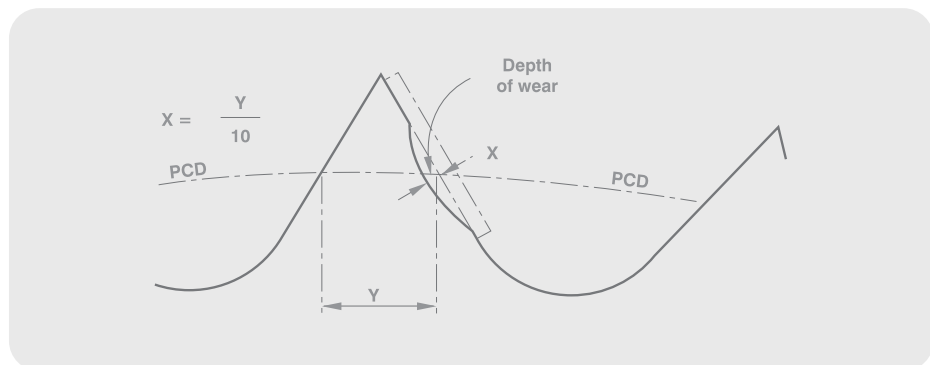

Chain Installation and Maintenance

Chain

Chain repair should not as a rule be necessary. A correctly selected and maintained chain should gradually wear out over a period of time, approximately 15000 hours, but it should not fail. A length extension check as detailed on page 84 will give an indication of the service life remaining.

If a transmission chain sustains damage due to an overload, jam-up, or by riding over the sprocket teeth, it should be carefully removed from the drive and given a thorough visual examination. Remove the lubricating grease and oil to make the job easier.

Depending on the damage, it may be practicable to effect temporary repairs using replacement links (shown on page 5). It is not, however, a guarantee that the chain has not been overstressed and so made vulnerable to a future failure. The best policy therefore is to remove the source of trouble and fit a new chain.

If a chain has failed two or more times, it is certain the chain will fail again in time. If no replacement is immediately available repair the chain, but replace it at the nearest opportunity.

The entire chain should be replaced because of the following reasons:

- The cost of down time to the system or machine can often outweigh the cost of replacing the chain.
- A new or even used portion of chain or joints assembled into the failed chain will cause whipping and load pulsation. This can and probably will produce rapid failure of the chain and will accelerate wear in both the chain and its sprockets.

Assembling Connecting Links

When assembling a connecting link with a slip fit outer plate, it is necessary that this plate is pushed down on the pins to permit insertion of the fastener. Always ensure the No. 27 spring clip (as is illustrated on the No. 26 joint on page 5), has the closed end in the direction of rotation.

On a press fit connecting link it is necessary to drive the outer plate down far enough on the pins to allow insertion of the two split pins, but not so far as to create a tight joint.

By doing the above, three important things are accomplished.

- The desired clearances between the link plates across the chain width are maintained. Any outer link plate driven too far down the pins 'squeezes' the joint, so that no lubrication can get to the bearing surfaces. Such 'squeezing' of a joint prevents a chain articulating freely around the sprockets.
- Correct assembly of a connecting link into a chain will ensure a smooth gearing action with a minimum of whipping.
- With the split pins or spring clip snugly positioned against the side plate and the closed end of a spring clip fitted in the right direction, there will be less of a tendency for them to work loose and fall off.

Safety Warnings

Connecting links

No. 11 or No. 26 joints (slip fit) should not be used where high speed or arduous conditions are encountered. In these or equivalent circumstances where safety is essential, a riveting link No. 107 (interference fit) must be used.

Good design practices

For high speed drives or drives operating in arduous conditions, a properly riveted outer link (No. 107) should always be used for optimum security, in preference to any other form of chain joint.

The use of other connectors and cranked links (No. 12 and No. 30) should always be restricted to light duty, non-critical applications, in drives where an odd number of pitches is absolutely unavoidable.

Wherever possible, drives should have sufficient overall adjustment to ensure the use of an even number of pitches throughout the useful life of the chain. A cranked link joint should only be used as a last resort.

Health and Safety Warning

The following precautions must be taken before disconnecting and removing a chain from a drive prior to replacement, repair or length alteration.

1. Always isolate the power source from the drive or equipment.
2. Always wear safety glasses.
3. Always wear appropriate protective clothing, hats, gloves and safety shoes as warranted by the circumstances.
4. Always ensure tools are in good working condition and used in the proper manner.
5. Always loosen tensioning devices.
6. Always support the chain to avoid sudden unexpected movement of chain or components.
7. Never attempt to disconnect or reconnect a chain unless the chain construction is fully understood.
8. Always ensure that directions for the correct use of any tools are followed.
9. Never re-use individual components.
10. Never reuse a damaged chain or chain part.
11. On light duty drives where a spring clip (No. 27) is used, always ensure that the clip is fitted correctly with the closed end pointing in the direction of travel.

Chain Installation and Maintenance

Troubleshooting

| Problem | Probable Cause | Solution |
|--|--|--|
| Chain climbing or jumping off the sprocket teeth | <ul style="list-style-type: none"> Chain or sprockets worn Chain excessively slack Insufficient chain wrap Foreign material build up in the sprocket tooth gaps | <ul style="list-style-type: none"> Replace the chain and sprockets if necessary Adjust the centre distance or introduce a jockey sprocket to take up the slack. if allowable, shorten the chain For large ratio drives, the driver sprocket may not have enough teeth to absorb the working tension. if the drive cannot be altered, introduce a jockey sprocket to increase the chain wrap Clean the sprocket teeth of all material so that the chain engages correctly |
| Chain drive running hot | <ul style="list-style-type: none"> Lubrication method or type of lubrication is unsuitable for the operating speed and power being transmitted Insufficient lubrication Chain continually hitting an obstruction Incorrect chain size selected for the speed and transmitted power | <ul style="list-style-type: none"> Check the catalogue selection tables for the correct lubrication method Increase the frequency of lubrication in line with good maintenance practice Remove the obstruction Check the chain selection as a smaller pitch or multistrand chain of equivalent capacity may be required |
| Chain elongation (A gradual increase over its life is normal) | <ul style="list-style-type: none"> Lubrication failure An overload Displacement of the bearings Failure of the tensioning device | <ul style="list-style-type: none"> Replace chain and sprockets Check lubrication, drive configuration and loadings Monitor drive elongation over a period of 2-3 months by checking the degree of sag Contact our technical staff for advice if problem persists |
| Chain stiffens, starts to whip | <ul style="list-style-type: none"> Worn chain or sprockets Excessively slack chain Heavy & impulsive load Centre distance too long One or more stiff joints | <ul style="list-style-type: none"> Replace chain and sprockets Adjust centres if possible or introduce a take-up system such as a jockey sprocket. it is also possible to shorten the chain by one or more pitches Reduce the loading Add a jockey sprocket on long centre distances remove or repair stiff joints |

Chain Installation and Maintenance

Troubleshooting

| Problem | Probable Cause | Solution |
|--|--|---|
| Excessive noise | <ul style="list-style-type: none"> Misalignment of sprockets Inadequate lubrication Worn or incorrectly fitted bearings Chain excessively slack or tight Worn chain or sprockets Tight joints Heavy impulsive loads Chain pitch size too large Obstruction in the chains path | <ul style="list-style-type: none"> Misalignment introduces abnormal loading and wear. Recheck alignment to maintain normal drive conditions Improve the lubrication method to ensure the proper amount of lubrication is available in the bearing areas Replace or correct the bearings as these will malign the entire drive Adjust the centre distance if possible or introduce a jockey sprocket Replace the chain and where necessary the sprockets. Consider hardened teeth Replace or repair joints Reduce the load or introduce a jockey sprocket Check the chain selection or contact our technical staff Remove the obstruction |
| Heavy wear on sprocket Teeth working faces. (A bright polished appearance is normal) | <ul style="list-style-type: none"> Poor lubrication Presence of abrasive | <ul style="list-style-type: none"> Improve the method of lubrication, (see lubrication section) Check for presence of foreign materials and eliminate the source. Replace sprockets and chain if necessary |
| Pin fails | <ul style="list-style-type: none"> System loading is greater than the capacity of the chain | <ul style="list-style-type: none"> Check the kilowatt rating table to determine if the chain capacity has been exceeded. Larger pitch chain or a multistrand chain may be required if the load conditions cannot be corrected |
| Roller or bush fails | <ul style="list-style-type: none"> Chain capacity has been exceeded at high speed causing impact on the sprocket teeth Tooth marks on the outside of the roller diameter can initiate failure | <ul style="list-style-type: none"> Check the drive selection. A smaller pitch chain, a multistrand chain or sprockets with more teeth may be required If the rollers are marked by the sprocket teeth, adjust the centre distance |

Chain Installation and Maintenance

Troubleshooting

| Problem | Probable Cause | Solution |
|---|--|---|
| Rust present on chain | <ul style="list-style-type: none"> Inadequate lubrication. This will also affect the joints which will be discoloured, (light to dark brown) and could be rough, grooved or galled | <ul style="list-style-type: none"> Remove several joints and check that the components are not severely damaged. <p>Replace chain and sprockets as necessary</p> <p>Improve lubrication method</p> |
| Side plate fails | <ul style="list-style-type: none"> Fatigue failure is caused by repetitively loading the chain above its limit Impulsive drive conditions can also cause fatigue failure | <ul style="list-style-type: none"> Check the drive selection, a larger pitch chain or a multistrand chain may be required If not the above, check for excessive slack. This may indicate worn chain and sprockets. Replace where required |
| Side plates are worn | <ul style="list-style-type: none"> Wear on the inside of the plate is caused by sprocket misalignment Wear on the top of the side plate is caused by the chain rubbing against the chaincase or some obstruction | <ul style="list-style-type: none"> Check and adjust sprocket and shaft alignment Remove source of rubbing by removing the obstruction or adding a jockey sprocket to control the slack in the chain |
| Wear on the sides of the sprocket teeth | <ul style="list-style-type: none"> Drive misalignment | <ul style="list-style-type: none"> Check and correct sprocket and shaft alignment |

Section 2

Designer Guide Specification Guideline

Renold Chain Designer Guide

Development of Early Roller/Bush Chain

As the industrial revolution gained pace, the need for higher performance chain ensured that the product did not stand still. A quick look at the 1880 patent would give the impression that there is no difference between it and modern chain.

In concept, this is true. However, early chain performance was very much constrained by design knowledge, material sophistication and production processes. For example, in order to achieve a close tolerance on round parts, Hans Renold also pioneered centreless grinding and at one time had a whole section devoted to grinding cold drawn bar to size before further processing.

The shortcomings of available technology meant that, compared with modern chain, there were low strength to weight ratios, erratic pitch control, poor engagement characteristics and a tendency toward point loading, causing high bearing pressures, wear and failure. The ever increasing number of applications for chain resulted in a continuous refinement of our production processes and the introduction of heat treatment, improving Renold Chain to meet these new and arduous demands.

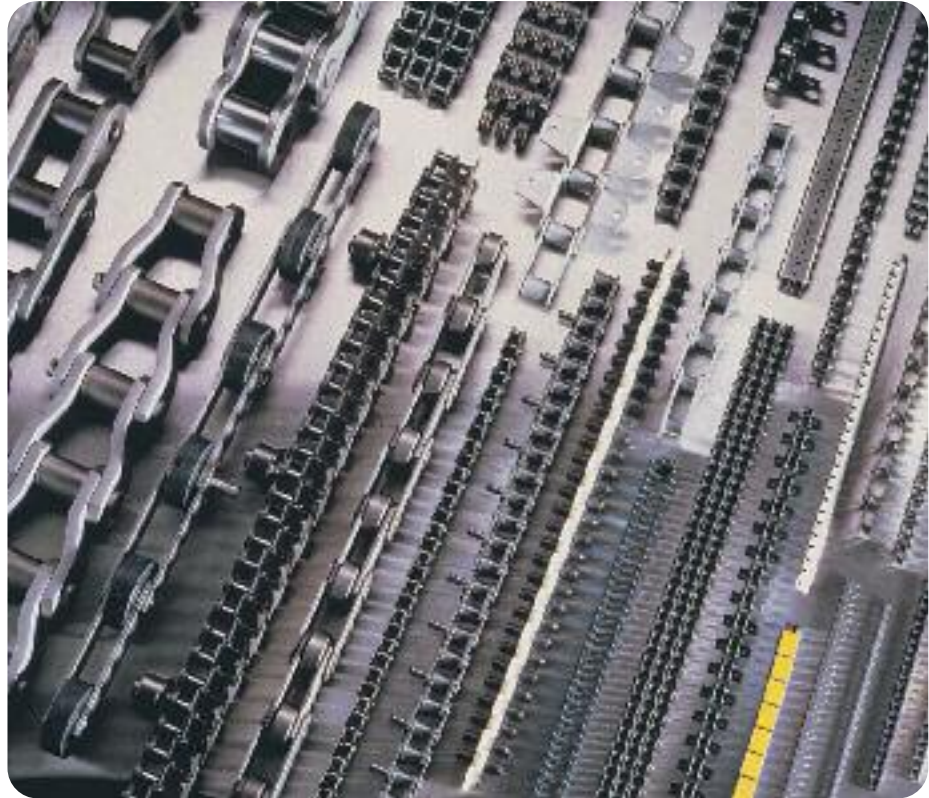

Modern Chain

There is today a very wide range of chain products available. Some of these are special low volume products, for example nuclear waste handling chain. Other high volume products such as motorcycle chain are an offshoot of one of the key groups shown below.

At the top level of the chain groups, conveyor chain is perhaps the most difficult to compartmentalise, since most types of chain can be used to convey. There is, however, a range of so called conveyor chain products typified by its long pitch, large roller diameter and emphasis on tensile strength rather than fatigue life.

Cranked link chain, like conveyor chain, is intended to run only at low speeds, since the presence of a cranked plate will reduce fatigue life. This chain tends to be used in conveying applications where harsh environmental conditions prevail, in mineral excavation for example.

Leaf chain is similar in construction to the old Galle chain, except that plates are interleaved in various configurations right across the width of the pin. This means that there is no way of providing sprocket engagement and the chain can only be used to transmit force through suitably anchored ends. Chains are guided around simple plain pulleys. Perhaps the best example of the use of leaf chain is in the lifting mechanism of a fork lift truck.

This leaves the most important group of chain, the European and American series of transmission chain. The European (from the old British Standard) range, grew out of the early pioneering work of Hans Renold, as mentioned above, and the size of components through the range therefore reflected a growing understanding of chain design and probably was influenced by the availability of stock material sizes. The American or ANSI range, which came later, has a clear mathematical theme, whereby the sizes of components are calculated in accordance with expressions now quoted in the ANSI standard B29.1. It should also be mentioned here that the ANSI range of chain is shadowed by a range of similar chains, but using the side plate material from the chain of the next highest size. This results in a range of chains with higher fatigue life but not necessarily higher tensile strength, since the pin diameters are unchanged.

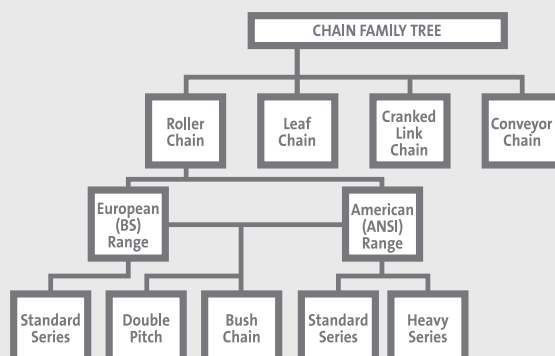

Renold Chain Designer Guide

Both European and ANSI ranges of chain are available in double pitch and bush chain forms. Double pitch is primarily another form of conveyor chain using the round parts from a standard chain, but having twice the pitch.

Bush chain is simply roller chain without a roller and is also the only design configuration possible on very small pitch chain, such as 4mm and ANSI 25 or 1/4 inch pitch. Bush chain is used for lightly loaded applications or those requiring only direct pull.

Modern chain has features incorporated which enable demanding applications to be tackled with ease. These include high wear and fatigue resistance and transmission efficiency of around 98%.

Chain is also now manufactured in multiple strands joined together by a common pin, giving more scope for increased power transmission in restricted space. The range of products now available with alternative materials, special coatings, endless varieties of attachments, hollow bearing pins and anti-backbend, to name just a few, give scope for the widest portfolio of design solutions imaginable.

Together with improvements to factory applied greases and better understanding of applicational techniques, designers can now specify transmission chain with confidence.

Chain Performance

Renold Chain products that are dimensionally in line with the ISO standard far exceed the stated ISO minimum tensile strength requirements. However Renold does not consider breaking load to be a key indicator of performance because it ignores the principal factors of wear and fatigue. In these areas, Renold products are designed to produce the best possible results and independent testing proves this.

In this catalogue, where the ISO breaking load is quoted, it should be noted that we are stating that the Renold product conforms to the ISO minimum standard. Independent test results show that the minimum (many companies quote averages) breaking loads were far in excess of the ISO minimum.

Where the quoted breaking load is not described as being the ISO minimum, the product has no relevant ISO standard. In this case, the breaking loads quoted are the minimum guaranteed.

The performance of a chain is governed by a number of key factors. The tensile strength is the most obvious since this is the means by which a chain installation is roughly sized. However, since a chain is constructed from steel, the yield strength of which is around 65% of the ultimate tensile strength, any load above this limit will cause some permanent deformation to take place with consequent rapid failure.

Reference to the s-n curve below shows that at loads below this 65% line, finite life may be expected and at subsequent reductions in load the expected life increases until the fatigue endurance limit is reached at around 8,000,000 operations.

Loads below 10,000,000 will result in infinite fatigue life. The failure mode will then become wear related which is far safer, since a controlled monitor of chain extension can take place at suitable planned intervals. In practice, if a load ratio of tensile strength to maximum working load of 8:1 is chosen, then the endurance limit will not normally be exceeded. Careful consideration of the expected maximum working loads should be given since these are often much higher than the designer may think! It is also a requirement that any passenger lift applications are designed with a safety factor of not less than 10:1.

In most applications the failure mode is designed to be wear and therefore some consideration of how a chain behaves in this mode are shown below.

Examination of the wear characteristics graph below shows that chain tends to wear in three distinct phases. The first phase, shown as 'bedding in', is a very rapid change in chain length associated with components adjusting to the loads imposed on them. The degree of this initial movement will depend to a large extent on the quality of chain used. For example, good component fits, chain pre-loaded at manufacture, plates assembled squarely etc. Renold chain has many features that minimise the degree of bedding in.

The second phase, shown as 'initial wear', might also be described as secondary 'bedding in'. This is caused firstly by the rapid abrasion of local high spots between the mating surfaces of the pin and bush, and secondly by displacement of material at the bush ends. This is explained more clearly by the inner link assembly diagram shown, where it may be seen that in order to ensure good fatigue life, the bush and plate have a high degree of interference fit resulting in a tendency of the bush ends to collapse inwards slightly. This localised bulge will wear rapidly until the pin bears equally along the length of the bush. Renold limits this effect by introducing special manufacturing techniques. Some manufacturers maintain cylindricity by reducing the interference fit to a very low level. This reduces fatigue performance.

The final steady state wear will continue at a very low rate until the chain needs renewal. In a correctly designed and lubricated system, 15 000 hours continuous running should be normal.

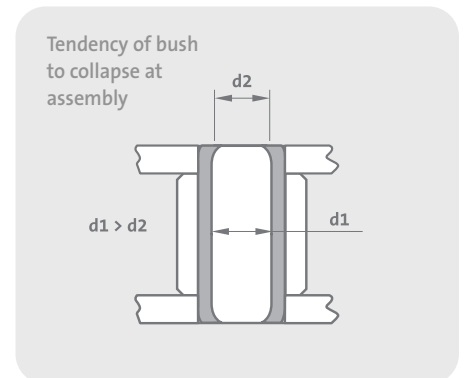
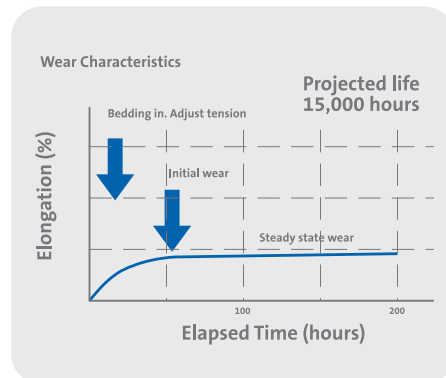
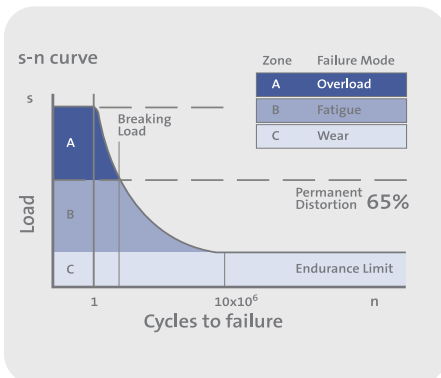

Renold Chain Designer Guide

The reason that wear takes place at all is demonstrated with reference to the Stribeck diagram below. It may be seen from this that where two mating surfaces are in contact, the coefficient of friction is very high at the point of initial movement, known as static friction.

The reason for this is that the surface irregularities of the two bodies are interlocked with little or no separating lubrication layer. As the surface speeds increase, lubricant is drawn between the two surfaces and friction takes place with some surface contact. This condition is known as 'mixed friction'. These two conditions result in material loss over time. With a continuing increase in surface speed, hydrodynamic friction takes place, a condition where there is no metal to metal contact.

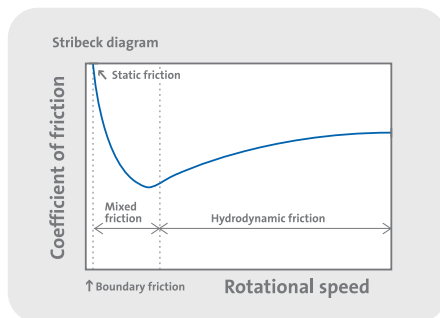

If we consider the action of the mating surfaces of the bush and pin during one cycle of a two sprocket system, it will quickly be realised that these components are stationary with respect to each other during travel from one sprocket to the other, and accelerate rapidly through a very small angle when engaging with the sprocket before coming to rest once more. This means that the pin/bush combination is operating between the static and mixed friction states and that lubrication will therefore be an important aspect of system design.

Wear Factors

As already shown, wear takes place from the friction between the mating of the pin and bush. The rate of wear is primarily determined by the bearing area and the specific pressure on these surfaces. The hardened layers of the pin and bush are eroded in such a way that the chain will become elongated.

ELONGATION may amount to a MAXIMUM of 2% of the nominal length of the chain. Above 2% elongation, there can be problems with the chain riding up and jumping the sprocket teeth.

Elongation should be limited to 1% when:

- A sprocket in the system has 90 teeth or more.
- Perfect synchronisation is required.
- Centre distances are greater than recommended and not adjustable.

When the demands of the system become even higher, it is necessary to reduce the allowable percentage elongation further.

Wear depends on the following variables in a drive system:

- SPEED - The higher the speed of a system, the higher the frequency of bearing articulations, so accelerating wear.
- NUMBER OF SPROCKETS - The more sprockets used in a drive system, the more frequently the bearings articulate.

- NUMBER OF TEETH - The fewer the number of teeth in a sprocket, the greater the degree of articulation, the higher the wear.
- CHAIN LENGTH - The shorter the length of chain, the more frequently the bearings in the chain will have to operate, the faster wear takes place.
- LUBRICATION - As already shown, using the correct lubrication is critical to giving good wear life.

Chain Types

As with all engineered products, industry demands that chain be produced to a formal standard. The key transmission chain standards are summarised on page 96.

Simplex Chain



Standard ISO 606 ANSI B29.100

Duplex Chain



Standard ISO 606 ANSI B29.100

Triplex Chain

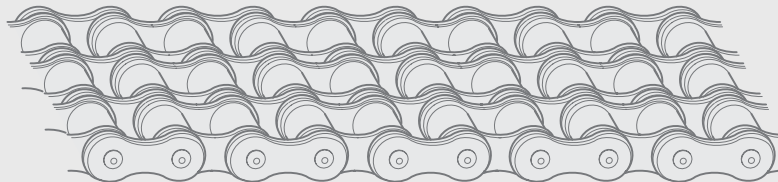

Standard ISO 606 ANSI B29.100

Renold Chain Designer Guide

International Standards

European Standard

Chains manufactured to the above standards are covered by ISO 606 and DIN 8187. These standards cover 3 versions:

- SIMPLEX
- DUPLEX
- TRIPLEX

The range of pitch sizes can vary between 4mm, (0.158 inch) to 114.3mm, (4.500 inch).

They are characterised by a large pin diameter, especially for the larger pitch sizes. This results in better wear resistance due to the greater bearing area.

The ISO standard has a simple form of part numbering, for example 1/2 inch pitch duplex chain would be 08B-2.

- The first two digits are the pitch size in 1/16's of an inch, therefore 08 = 8/16 or 1/2 inch.
- The letter 'B' indicates European Standard.
- The suffix 2 indicates the number of strands in the chain, in this case a duplex chain.

American Standard

American standard chains are covered by ISO 606, ANSI B29.1 and DIN 8188 and eight versions are covered.

- SIMPLEX, DUPLEX and TRIPLEX as for the European standard chains.
- QUADRUPLEX, 4 strands.
- QUINTUPLEX, 5 strands.
- SEXTUPLEX, 6 strands.
- OCTUPLEX, 8 strands.
- DECUPLEX, 10 strands.

The pitch sizes covered by this standard are 1/4 to 3 inch pitch.

American standard chains have a smaller pin diameter than their European standard equivalent. Wear resistance is therefore reduced when compared with European standard chains with the one exception, 5/8 inch pitch. In this case the pin and bush diameter is larger in an American standard chain.

American standard chains are normally referred to under the ANSI standard numbering system, for example a 1/2 inch pitch duplex chain would be, ANSI 40-2.

The ANSI numbering system works as follows:

- The first number is the pitch size in 1/8 inch, ie 4/8 = 1/2 inch pitch.
- The second number refers to the chain being a roller chain, 0 = roller chain. A 5 replacing the 0 would indicate a bush chain.
- The suffix, as with European standard chain, refers to the number of strands in the chain, that is 2 = duplex chain.

ANSI chain is also available in heavy duty options with thicker plates (H) and through hardened pins (V). An ANSI heavy chain would be specified using these suffixes.

- ie.
- | | |
|--------------|--|
| ANSI 140-2HV | Duplex, thick plates, through hardened pin |
| ANSI 80H | Simplex, thick plates |

Range of Application

The transmission chain market worldwide is divided between these two chain standards, based on the economic and historical influences within their regions.

- American standard chain is used primarily in the USA, Canada, Australia, Japan and some Asiatic countries.
- European standard chains dominate in Europe, the British Commonwealth, Africa and Asian countries with a strong British historical involvement.

In Europe around 85% of the total market uses European standard chain. The remaining 15% is American standard chains found on:

- Machinery imported from countries where American standard chain dominates.
- Machinery manufactured in Europe under licence from American dominated markets.

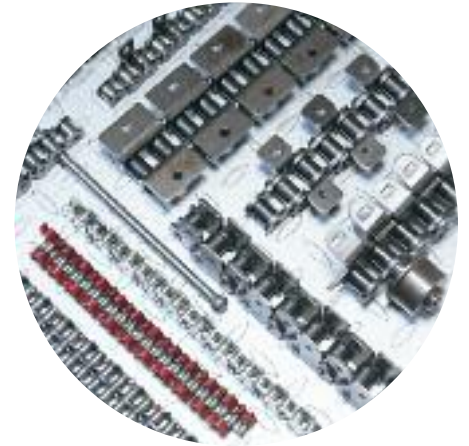

Chain Not Conforming to ISO Standards

There are also Renold manufacturing standards for special or engineered chain which can be split as follows:

1. HIGHER BREAKING LOAD CHAIN - This chain usually has plates that undergo a special treatment, has thicker side plate material and/or pin diameters that slightly deviate from the standards.
2. SPECIAL DIMENSIONS - Some chains can be a mixture of American and European standard dimensions or the inner width and roller diameters vary, such as in motorcycle chains.
3. APPLICATIONAL NEEDS - Special or engineered chain is manufactured for specific applicational use, examples being:
 - Stainless steel chain.
 - Zinc or nickel plated chain.
 - Chain with plastic lubricating bushes.
 - Chains with hollow bearing pins.
 - Chain that can bend sideways, (SIDEBOW).

In applications requiring a special or engineered chain, we would suggest that you contact our technical sales staff for more information.

Renold Chain Designer Guide

Standards Reference type

Transmission Chain Types

| | ISO | ANSI | Other |
|--|-------|--------|--------------------|
| Short Pitch Transmission Chain and Sprockets | 606 | B29.1M | DIN8187 DIN8188 |
| Short Pitch Bush Chains and Sprockets | 1395 | | DIN8154 |
| Double Pitch Roller Chain and Sprockets | 1275 | B29.3M | DIN8181 |
| Oilfield Chain and Sprockets | 606 | B29.1M | API Spec 7F |
| Cycle Chains | 9633 | | |
| Motorcycle Chains | 10190 | | |
| Cranked Link Chain and Sprockets | 3512 | B29.1M | DIN8182 |

Lifting Chain Types

| | ISO | ANSI | Other |
|--|------|--------|---------|
| Leaf Chain, Clevises and Sheaves | 4347 | B29.8M | DIN8152 |
| Roller Load Chains for Overhead Hoists | | | B29.24M |



Renold Chain Designer Guide

Advantages of Chain Drives

Steel transmission roller chain is made to close tolerances with excellent joint articulation, permitting a smooth efficient flow of power. Any friction between the chain rollers and sprocket teeth is virtually eliminated because the rollers rotate on the outside of the bushes, independent of bearing pin articulation inside the bush. As a result, very little energy is wasted and tests have shown chain to have an efficiency of between 98.4% and 98.9%.

This high level of efficiency, achieved by a standard stock chain drive under the correct conditions of lubrication and installation, is equalled only by gears of the highest standard with teeth ground to very close tolerances.

Roller chain offers a positive, non-slip driving medium. It provides an accurate pitch by pitch positive drive which is essential on synchronised drives such as those to automobile and marine camshafts, packaging and printing machinery. Under conditions of high speed and peak load when efficiency is also required, the roller chain has proved consistently quiet and reliable.

Centre distances between shafts can range from 50mm up to more than 9 metres in a very compact installation envelope. Drives can be engineered so that the sprocket teeth just clear each other or so that a considerable span is traversed by the chain. In this later category, double pitch chain comes into its own.

Roller chain has a certain degree of inherent elasticity and this, plus the cushioning effect of an oil film in the chain joints, provides good shock absorbing properties. In addition, the load distribution between a chain and sprocket takes place over a number of teeth, which assists in reducing wear. When, after lengthy service, it becomes necessary to replace a chain, this is simple and does not normally entail sprocket or bearing removal.

Roller chain minimises loads on the drive motor and driven shaft bearings since no pre-load is required to tension the chain in the static condition.

One chain can drive several shafts simultaneously and in almost any configuration of centre distance or layout. Its adaptability is not limited to driving one or more shafts from a common drive point. It can be used for an infinite variety of devices including reciprocation, racks, cam motions, internal or external gearing, counterbalancing, hoisting or weight suspension. Segmental tooth or 'necklace' chain sprocket rims can be fitted to large diameter drums.

Since there are no elastomeric components involved, chain is tolerant of a wide variety of environmental conditions, including extremes of temperature. Chain is used successfully in such harsh environments as chemical processing, mining, baking, rock drilling and wood processing. Special coatings can easily be applied for further enhancement.

Roller chain can also be fitted with link plate attachments and extended bearing pins etc., which allow them to be used for mechanical handling equipment and the operation of mechanisms. These attachments are detailed in this catalogue.

Roller chain drives are available for ratios up to 9:1 and to transmit up to 520 kW at 550 r.p.m. Beyond this, four matched strands of triplex chain can achieve 3200 kW at 300 r.p.m.

Roller chain does not deteriorate with the passage of time, the only evidence of age being elongation due to wear which normally is gradual and can be accommodated by centre distance adjustment or by an adjustable jockey sprocket. Provided a chain drive is selected correctly, properly installed and maintained, a life of 15000 hours can be expected without chain failure either from fatigue or wear. Where complete reliability and long life are essential, chains can be selected on their assured performance for applications such as hoists for control rods in nuclear reactors and control systems for aircraft.

Chain is a highly standardised product available in accordance with ISO Standards all over the world. It is also totally recyclable and causes no harmful effects to the environment.

Shown below is a simple table comparing the merits of different transmission/lifting media.

| Feature | Gears | Rope | Belt | Chain |
|---------------------|-------|------|------|-------|
| Efficiency | A | X | B | A |
| Positive Drive | A | X | B | A |
| Centre Distance | C | A | B | A |
| Elasticity | C | A | A | B |
| Wear Resistance | A | C | B | A |
| No Pre-load | A | C | C | A |
| Multiple Drives | C | X | C | A |
| Heat Resistant | B | B | C | A |
| Chemical Resistant | B | A | C | A |
| Oil Resistant | A | A | C | A |
| Adaptions | C | B | C | A |
| Power Range | A | X | B | A |
| Ease of Maintenance | C | B | B | A |
| Standardised | C | B | B | A |
| Environment | A | A | C | A |

A = Excellent
 B = Good
 C = Poor
 X = Not Appropriate

Note: To achieve the above ratings, different types of belt would be required

Renold Chain Designer Guide

Chain Selection

The notes given below are general recommendations and should be followed in the selection and installation of a chain drive, in order that satisfactory performance and drive life may be ensured.

Chain Pitch

The Rating Charts (pages 105 and 106) give the alternative sizes of chains that may be used to transmit the load at a given speed. The smallest pitch of a simplex chain should be used, as this normally results in the most economical drive. If the simplex chain does not satisfy the requirements dictated by space limitations, high speed, quietness, or smoothness of running, then consider a smaller pitch of duplex or triplex chain.

When the power requirement at a given speed is beyond the capacity of a single strand of chain, then the use of multi-strand drives permits higher powers to be transmitted.

These drives can also be made up from multiples of matched simplex, duplex or triplex ISO chains or in the case of ANSI chain, multiplex chain up to decuplex (10 strands) are available.

Please consult our technical staff for further information.

Maximum Operating Speeds

For normal industrial drives, experience has established a maximum sprocket speed for each pitch of chain. These speeds, which relate to driver sprockets having 17 to 25 teeth inclusive, are given in the graph below; they are applicable only if the method of lubrication provided is in line with recommendations.

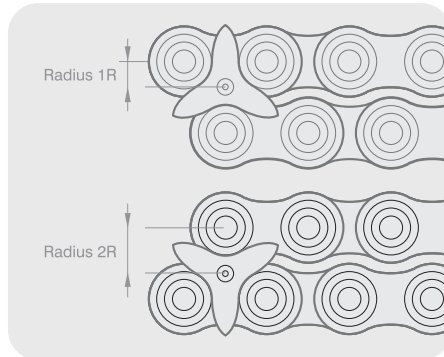
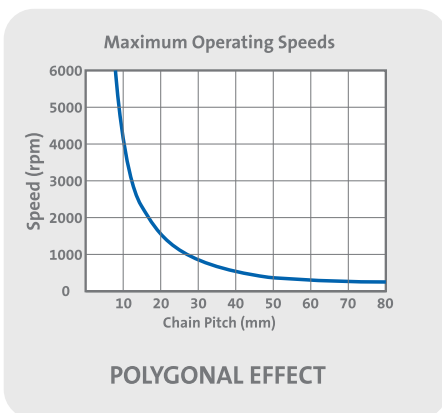

Polygonal Effect

Four important advantages of a chain drive are dependent directly upon the number of teeth in the driver sprocket (Z1).

The advantages are smooth uniform flow of power, quietness of operation, high efficiency and long life, the reason for their dependence being that chain forms a polygon on the sprocket. Thus, when the sprocket speed is constant, the chain speed (due to the many sided shape of its path around the teeth) is subject to a regular cyclic variation. This cyclic variation becomes less marked as the path of the chain tends towards a true circle and in fact, becomes insignificant for most applications as the number of teeth in the driver sprocket exceeds 19.

The effect of this cyclic variation can be shown in the extreme case of a driver sprocket with the absolute minimum number of teeth, i.e. three. In this instance, for each revolution of the sprocket the chain is subjected to a three-phase cycle; each phase being associated with the engagement of a single tooth. As the tooth comes into engagement, for a sixth of a revolution the effective distance, or driving

radius from the sprocket centre to the chain is gradually doubled; for the remaining sixth of a revolution, it falls back to its original position. Thus, as the linear speed of the chain is directly related to the effective driving radius of the driver sprocket, the chain speed fluctuates by 50% six times during each revolution of the driver sprocket.

As the graph below shows, the percentage of cyclic speed variation decreases rapidly as more teeth are added. With the driver sprocket of 19 teeth, therefore, this cyclic speed variation is negligible; hence we recommend that driver sprockets used in normal application drives running at medium to maximum speeds, should have not less than 19 teeth.

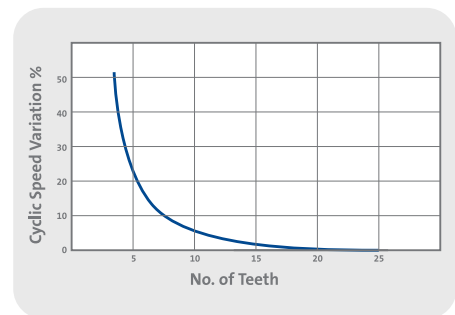

There are, however, applications where space saving is a vital design requirement and the speed/power conditions are such that the smaller numbers of teeth (i.e. below 17) give acceptable performance so that a compact, satisfactory drive is achieved, e.g. office machinery, hand operated drives, mechanisms, etc.

The limiting conditions with steady loading for using small numbers of teeth are:

| No. of Teeth | Percentage of Maximum Rated speed | Percentage of Maximum Rated power |
|--------------|-----------------------------------|-----------------------------------|
| 11 | 20 | 30 |
| 13 | 30 | 40 |
| 15 | 50 | 60 |
| 17 | 80 | 90 |

Renold Chain Designer Guide

Sprocket and chain compatibility

Most drives have an even number of pitches in the chain and by using a driver sprocket with an odd number of teeth, uniform wear distribution over both chain and sprocket teeth is ensured. Even numbers of teeth for both the driver and driven sprockets can be used, but wear distribution on both the sprocket teeth and chain is poor.

Number of Teeth

The maximum number of teeth in any driven sprocket (Z2) should not exceed 114. This limitation is due to the fact that for a given elongation of chain due to wear, the working pitch diameter of the chain on the sprocket increases in relation to the nominal pitch diameter, i.e. the chain assumes a higher position on the sprocket tooth. The allowable safe chain wear is considered to be in the order of 2% elongation over nominal length.

A simple formula for determining how much chain elongation a sprocket can accommodate is $\frac{200}{N}$

expressed as a percentage where N is the number of teeth on the largest sprocket in the drive system.

It is good practice to have the sum of teeth not less than 50 where both the driver and driven sprockets are operated by the same chain, e.g. on a 1:1 ratio drive, both sprockets should have 25 teeth each.

Centre Distance

For optimum wear life, centre distance between two sprockets should normally be within the range 30 to 50 times the chain pitch. On drive proposals with centre distances below 30 pitches or greater than 2m, we would recommend that the drive details are discussed with our technical staff.

The minimum centre distance is sometimes governed by the amount of chain lap on the driver sprocket, our normal recommendation in this circumstance being not less than 6 teeth in engagement with the chain.

Minimum 6 teeth

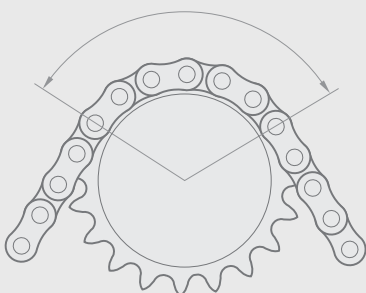

The centre distance is also governed by the desirability of using a chain with an even number of pitches to avoid the use of a cranked link, a practice that is not recommended except in special circumstances.

For a drive in the horizontal plane the shortest centre distance possible should be used consonant with recommended chain lap on the driver sprocket.

Formulae for the calculation of chain length and centre distance for two-point drives are given on page 103.

Recommended centre distances for drives are:

| Pitch | Inch mm | $\frac{3}{8}$ 9.525 | $\frac{1}{2}$ 12.70 | $\frac{5}{8}$ 15.87 | $\frac{3}{4}$ 19.05 | 1 25.40 | $1\frac{1}{4}$ 31.75 |
|--------------------|---------|---------------------|---------------------|---------------------|---------------------|---------|----------------------|
| Centre Distance mm | | 450 | 600 | 750 | 900 | 1000 | 1200 |

| Pitch | Inch mm | $1\frac{1}{2}$ 38.1 | $1\frac{3}{4}$ 44.45 | 2 50.80 | $2\frac{1}{2}$ 63.50 | 3 76.20 |
|--------------------|---------|---------------------|----------------------|---------|----------------------|---------|
| Centre Distance mm | | 1350 | 1500 | 1700 | 1800 | 2000 |

Lie of Drive

Drives may be arranged to run horizontally, inclined or vertically. In general, the loaded strand of the chain may be uppermost or lowermost as desired. Where the lie of the drive is vertical, or nearly so, it is preferable for the driver sprocket (Z1) to be above the driven sprocket (Z2); however, even with a drive of vertical lie it is quite feasible for the driver sprocket to be lowermost, provided care is taken that correct chain adjustment is maintained at all times.

CENTRES

The centre distance between the axis of two shafts or sprockets

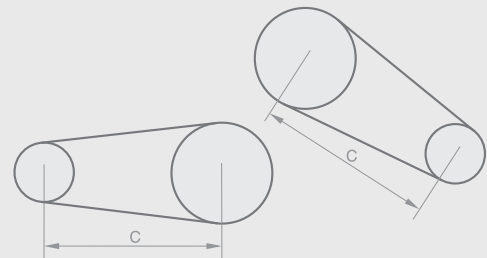

ANGLE

The lie of the drive is given by the angle formed by the line through the shaft centres and a horizontal

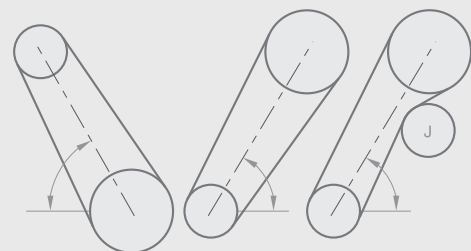

ROTATION

Viewed along the axis of the driven shaft the rotation can be clockwise or anti-clockwise

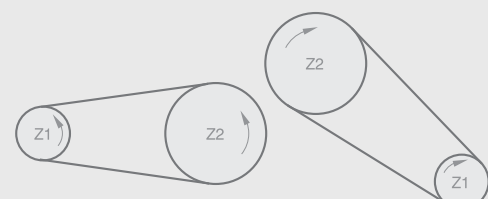

Renold Chain Designer Guide

Drive Layout

One chain can be used for driving a number of shafts and due to the ability of roller chains to gear on either face, individual shafts in the same drive can be made to rotate in the same or opposite directions by arranging the driven sprockets to gear in different faces of the chain.

The number of driven sprockets permissible in any one drive depends on the layout.

A selection of possible drive layouts is shown below.

Section 2

Drives with Variable Shaft Positions

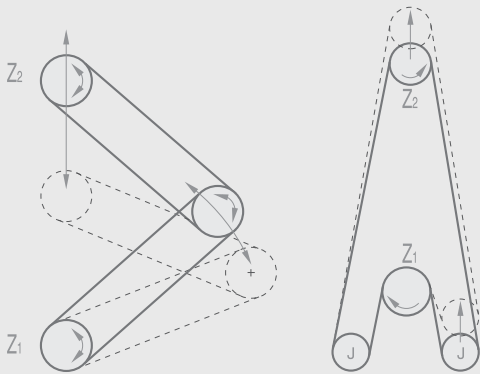

Floating countershaft and floating jockey
CHAIN LAP - Recommended 120°. Minimum of 90° permissible for sprockets of 27 teeth or over.
CENTRES - Pitch of chain multiplied by 30 to 50.

Drives with Abnormally Long Centres

Could incorporate countershafts

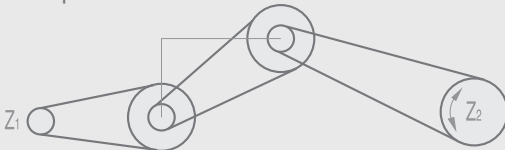

Or supporting jockeys

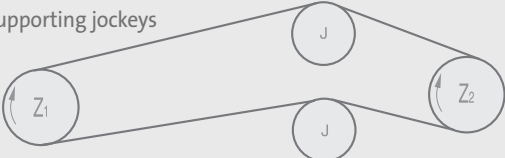

For slow and medium chain speed applications up to 150 metres per minute.

Or supporting guides

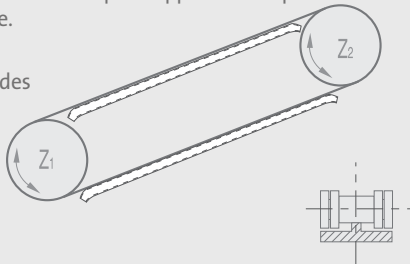

For applications where countershafts or supporting jockeys cannot be employed and where the chain speed does not exceed 60 metres per minute.

Multi-shaft Drives

The permissible number of driven shafts will vary according to drive characteristics.



Five sprockets coupled by four simple drives.

Whilst the efficiency of a single stage drive is approximately 98%, where a series of drives are interconnected as in live roller conveyors, the overall efficiency will vary with the number of drives involved. It is necessary in applications of this nature to increase the calculated motor power to allow for this reduced efficiency.

- 4 drives overall efficiency = 94%
- 8 drives overall efficiency = 87%
- 12 drives overall efficiency = 80%

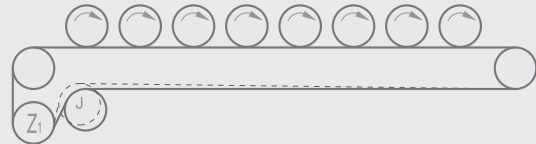

Eight shafts rotated by a single chain with high efficiency but reduced tooth contact. The jockey is used to ensure adequate chain lap on the driven sprockets.

Horizontal Drives

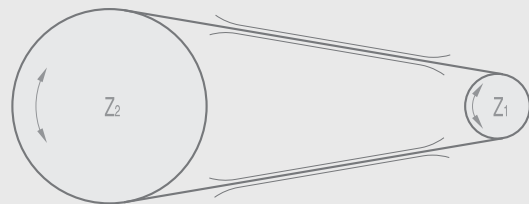

Plan

Two shafts vertically mounted

When centres are long, use guide strips to support chain strands with generous 'lead-in' to ensure smooth entry and exit of chain.

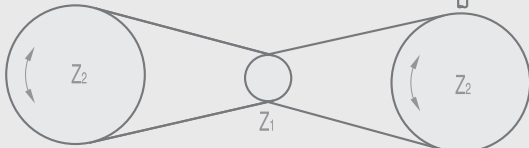

Three shafts vertically mounted

CHAIN LAP - Recommended 120°. Minimum of 90° permissible for sprockets of 27 teeth or over.
CENTRES - Shortest possible.

Renold Chain Designer Guide

Selection Method

Introduction

Chain selected using this method will have a minimum life expectancy with proper installation and lubrication of 15000 hours.

Warning

The rating charts page 105 and page 106 exceed the minimum standards and selection of chain using the figures quoted in this section is only valid for RENOLD CHAIN. Use our interactive Chain Selector on www.renold.com.

Symbols, Terms and Units

| | |
|----|--------------------------------------|
| Z1 | = Number of teeth on drive sprocket |
| Z2 | = Number of teeth on driven sprocket |
| C | = Centre distance (mm) |
| P | = Chain pitch (mm) |
| i | = Drive ratio |
| L | = Chain length (pitches) |

In order to select a chain drive the following essential information must be known:

- The power in kilowatts to be transmitted.
- The speed of the driving and driven shafts.
- The characteristics of the drive.
- Centre distance.

From this base information the selection power to be applied to the ratings chart is derived.

| Selection Summary | Page |
|--|---------|
| 1 Select drive ratio and sprockets Z1 = 19 teeth minimum | 101 |
| 2 Establish selection application factors f1 takes account of dynamic loads Tooth factor f2 (19/Z1) | 102 |
| 3 Calculate selection power = power x f1 x f2 (kW) | 103 |
| 4 Select chain drive | 103 |
| 5 Use rating charts | 105-106 |
| 6 Calculate chain length using formulae | 103 |
| 7 Calculate exact centre distance | 103 |
| Finally Choose lubrication method | 107 |

1 - Select Drive and Ratio

Chart 1 may be used to choose a ratio based on the standard sprocket sizes available. It is best to use an odd number of teeth combined with an even number of chain pitches.

Ideally, chain sprockets with a minimum of 19 teeth should be chosen. If the chain drive operates at high speed or is subjected to impulsive loads, the smaller sprockets should have at least 25 teeth and should be hardened.

It is recommended that chain sprockets should have a maximum of 114 teeth.

Drive ratio can otherwise be calculated using the formula:

$$i = \frac{Z2}{Z1}$$

For large ratio drives, check that the angle of lap on Z1 is not less than 120 degrees.

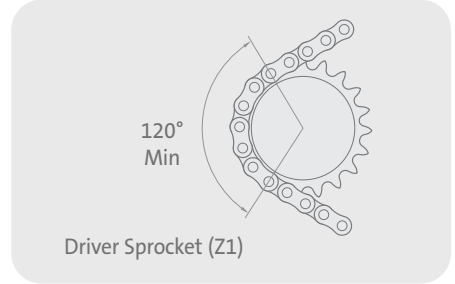

SELECT DRIVE RATIO AND SPROCKETS - $\frac{Z2}{Z1}$

Chain Reduction Ratios to One Using Preferred Sprockets

Chart 1

| No. of Teeth Driven Sprocket Z2 | No. of Teeth Drive Sprocket Z1 | | | | | |
|---------------------------------|--------------------------------|------|------|------|------|------|
| | 15 | 17 | 19 | 21 | 23 | 25 |
| 25 | - | - | - | - | - | 1.00 |
| 38 | 2.53 | 2.23 | 2.00 | 1.80 | 1.65 | 1.52 |
| 57 | 3.80 | 3.35 | 3.00 | 2.71 | 2.48 | 2.28 |
| 76 | 5.07 | 4.47 | 4.00 | 3.62 | 3.30 | 3.04 |
| 95 | 6.33 | 5.59 | 5.00 | 4.52 | 4.13 | 3.80 |
| 114 | 7.60 | 6.70 | 6.00 | 5.43 | 4.96 | 4.56 |

For recommended centre distances see page 99

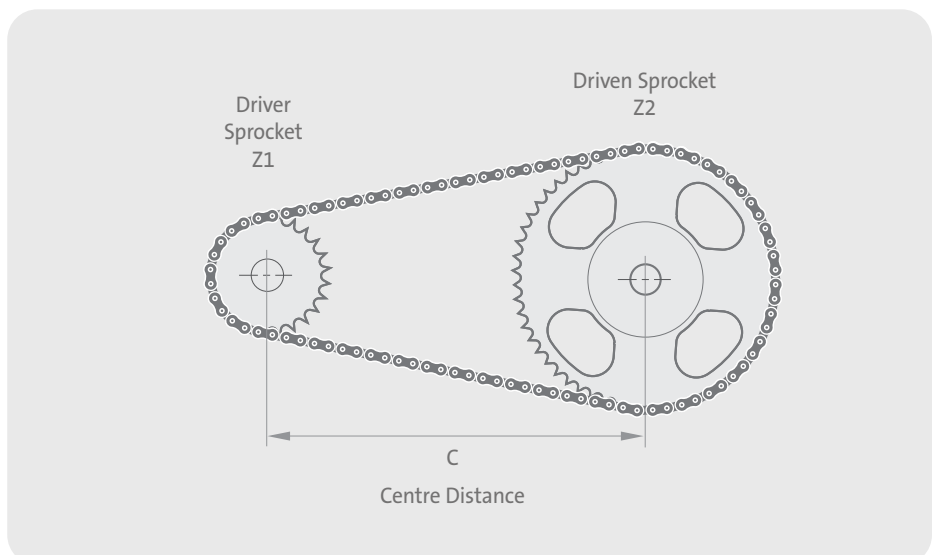

Renold Chain Designer Guide

Section 2

2 - Establish Selection Factors

The following factors will be used later on to determine the selection power.

Application Factor f1

Factor f1 takes account of any dynamic overloads depending on the chain operating conditions. The value of factor f1 can be chosen directly or by analogy using chart 2.

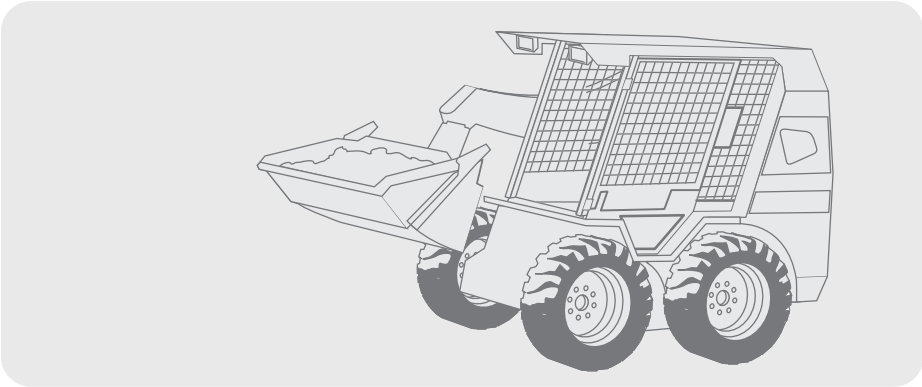

Chart 2

| DRIVEN MACHINE CHARACTERISTICS | | CHARACTERISTICS OF DRIVER | | |
|--------------------------------|---|--|---|--|
| | | SMOOTH RUNNING Electric Motors, Steam and Gas Turbines, Internal Combustion Engines with Hydraulic coupling | SLIGHT SHOCKS Internal Combustion Engines with 6 cyls or more with mechanical Coupling, Electric Motors with frequent starts | MODERATE SHOCKS Internal Combustion Engines with less than 6 cyls, with mechanical coupling |
| SMOOTH RUNNING | Centrifugal Pumps and Compressors, Printing Machines, Paper Colanders, Uniformly Loaded Conveyors, Escalators, Liquid Agitators and Mixers, Rotary Driers, Fans | 1 | 1.1 | 1.3 |
| MODERATE SHOCKS | Pumps and Compressors (3+ cyls), Concrete Mixing Machines, Non uniformly Loaded Conveyors, Solid Agitators and Mixers | 1.4 | 1.5 | 1.7 |
| HEAVY SHOCKS | Planers, Excavators, Roll and Ball Mills, Rubber Processing Machines, Presses and Shears 1 & 2 Cyl Pumps and Compressors, Oil Drilling Rigs | 1.8 | 1.9 | 2.1 |

Tooth Factor f2

The use of a tooth factor further modifies the final power selection. The choice of a smaller diameter sprocket will reduce the maximum power capable of being transmitted since the load in the chain will be higher.

Tooth factor f2 is calculated using the formula

$$f2 = \frac{19}{Z1}$$

Note that this formula arises due to the fact that selection rating curves shown in the rating charts (see pages 105 and 106) are those for a 19 tooth sprocket.

| f2 factors for standard sprocket sizes | |
|--|------|
| Z1 | f2 |
| 15 | 1.27 |
| 17 | 1.12 |
| 19 | 1.00 |
| 21 | 0.91 |
| 23 | 0.83 |
| 25 | 0.76 |

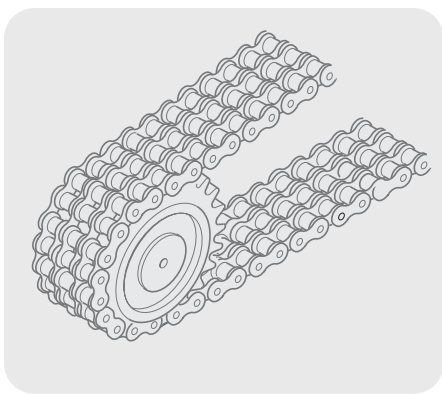

Renold Chain Designer Guide

3 - Calculate The Selection Power

Multiply the power to be transmitted by the factors obtained from STEP TWO.

Selection POWER = POWER to be transmitted x f1 x f2 (kW).

This selection power can now be used with the appropriate rating chart, see pages 105 and 106.

4 - Select Chain Drive

From the rating chart, select the smallest pitch of simplex chain to transmit the SELECTION POWER at the speed of the driving sprocket Z₁.

This normally results in the most economical drive selection. If the SELECTION POWER is now greater than that shown for the simplex chain, then consider a multiplex chain of the same pitch size as detailed in the ratings chart.

5 - Calculate Chain Length

To find the chain length in pitches (L) for any contemplated centre distance of a two point drive, use the formula below:

$$\text{Length (L)} = \frac{Z_1 + Z_2}{2} + \frac{2C}{P} + \frac{\left(\frac{Z_2 - Z_1}{2P}\right)^2 \times P}{C}$$

The calculated number of pitches should be rounded up to a whole number of even pitches. Odd numbers of pitches should be avoided because this would involve the use of a cranked link which is not recommended. If a jockey sprocket is used for adjustment purposes, two pitches should be added to the chain length (L).

C is the contemplated centre distance in mm and should generally be between 30 - 50 pitches.

e.g. for 1 1/2" pitch chain C = 1.5 x 25.4 x 40 = 1524mm.

6 - Calculate Exact Centre Distance

The actual centre distance for the chain length (L) calculated by the method above, will in general be greater than that originally contemplated. The revised centre distance can be calculated from the formula below.

$$C = \frac{P}{8} \left[2L - Z_2 - Z_1 + \sqrt{(2L - Z_2 - Z_1)^2 - \left(\frac{P}{3.88}\right) (Z_2 - Z_1)^2} \right]$$

Where:

- P = Chain pitch (mm)
- L = Chain length (pitches)
- Z₁ = Number of teeth in driver sprocket
- Z₂ = Number of teeth in driven sprocket

Drive with Multiple Sprockets

When designing a drive with multiple sprockets, the chain length calculation becomes more complicated. Most CAD systems, however, can be used to calculate chain length by wrapping a polyline around the PCD's of each sprocket. A scale manual drawing could also give a fairly accurate result as follows:

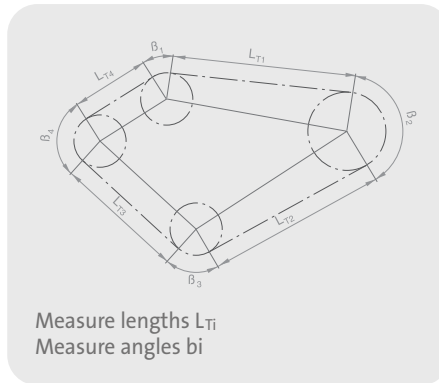

The theoretical length in pitches can now be calculated by the addition of all L_{Ti} and b values using the following formula.

Where

- P = The Chain pitch
- Z_i = The Number of teeth

$$\text{Number of pitches} = \frac{1}{P} \sum_{i=1}^{i=n} L_{Ti} + \sum_{i=1}^{i=n} \frac{b_i Z_i}{360}$$

This calculation method can also be applied on drives where the chain is driven on guide rails or around jockey sprockets. These should be considered as ordinary sprockets.

Sprockets for Transmission Chain

Renold manufacture a comprehensive range of stock sprockets for European standard chains up to 2 inch pitch.

Other sizes of sprocket, including those to American standard dimensions, are available on request.

Special sprockets are also manufactured on request, in special materials or formats, normally to suit a specific application in harsh or difficult drive situations, examples being:

- Sprockets incorporating shafts.
- Welded or detachable hubs.
- Shear pin devices fitted.
- Necklace sprockets made up of chain plates and individual tooth sections for turning large drums or tables.
- Combination sprockets (two or more sprockets combined having different pitch sizes and numbers of teeth).
- Sprockets in two or more sections, ie split sprockets or segmental sprockets.

Renold Chain Designer Guide

Selection of Sprocket Materials

Choice of material and heat treatment will depend upon shape, diameter and mass of the sprocket. The table below can be used as a simple guide on the correct selection of sprocket material.

| Sprocket Running | Smooth Shocks | Moderate Shocks | Heavy Shocks |
|------------------|---------------|--|--|
| Up to 29T | EN8 or EN9 | EN8 or EN9 Hardened and Tempered or Case Hardened Mild Steel | EN8 or EN9 Hardened and Tempered or Case Hardened Mild Steel |
| 30T and over | Cast Iron | Mild Steel or Meehanite | EN8 or EN9 Hardened and Tempered or Case Hardened Mild Steel |

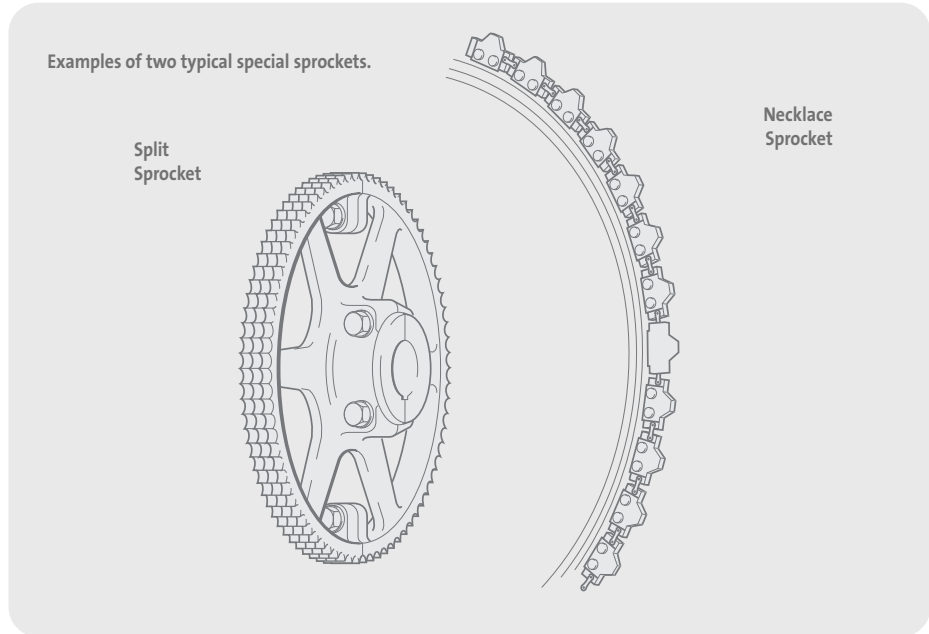

Section 2

Kilowatt ratings, for European and ANSI chains, shown in the ratings charts are based on the following conditions:-

- Service factor of 1.
- Wheel centre distance of 30 to 50 times the chain pitch.
- Speed of driver sprocket (Z1) whether on the driving or driven shaft.
- Two sprocket drive arrangement.
- Adjustment by centre distance or jockey on unloaded strand.
- Riveted endless chain (press fit connector).
- Correct lubrication.
- Accurate shaft/sprocket alignment.

Under these conditions a service life of approximately 15,000 hours can ordinarily be expected when the chain operates under full rating. The kilowatt ratings for multiple strand European chains up to triplex are given respectively in columns 2 and 3, for ANSI chains up to quadruplex in columns 2, 3 and 4.

Rating Chart Construction

The rating charts at first sight look complicated, however, they are constructed from 3 simple lines. From this it may be seen that at lower speeds the failure mode is likely to be plate fatigue if the maximum power recommendation is exceeded. However, pin galling will occur due to boundary lubrication break down at very high speeds. At the intersection of these lines the bush and roller fatigue curve comes into play and accounts for the rounded tops to each of the selection curves.

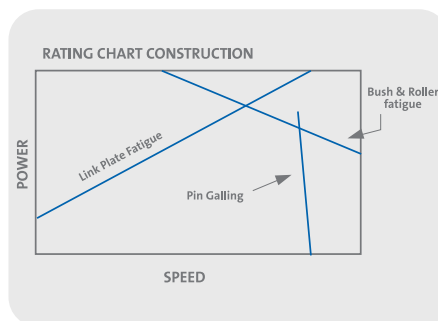

Bearing Pressures

When a chain has been correctly selected, the mode of failure over a very long period of time is most likely to be wear.

The subject of wear, which depends on many factors, has been addressed earlier in this guide, however, a very useful indicator of the likely wear performance is the magnitude of pressure between the key mating surfaces i.e. pin and bush.

This pressure is known as the bearing pressure and is obtained by dividing the working load by the bearing area. Bearing areas for standard chains are quoted in the designer data at the end of this guide.

The following table gives an indication of the implications of various bearing pressures but should not be used without reference to the other chain selection methods given in this guide.

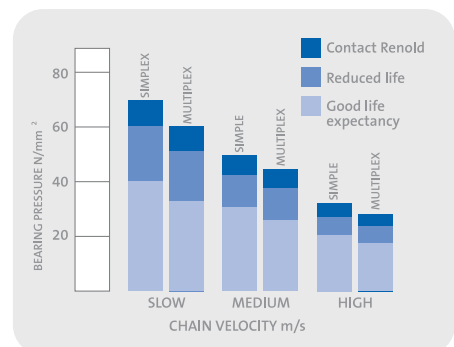

Slow velocity up to 60% of maximum allowable speed.
 Medium velocity 60 to 80% of maximum allowable speed.
 High velocity over 80% of maximum allowable speed.

Note: there is some variation between chains, and the above figures should be used as a guide only.

Renold Chain Designer Guide

European Chain Rating Chart

European Standard Chain Drives

Rating Chart using 19T Driver Sprocket

These ratings charts are based on standard Renold-brand transmission chain. For guidance on other chain types, go to www.renold.com/chainsselector and use the exclusive Renold Chain Selector software.

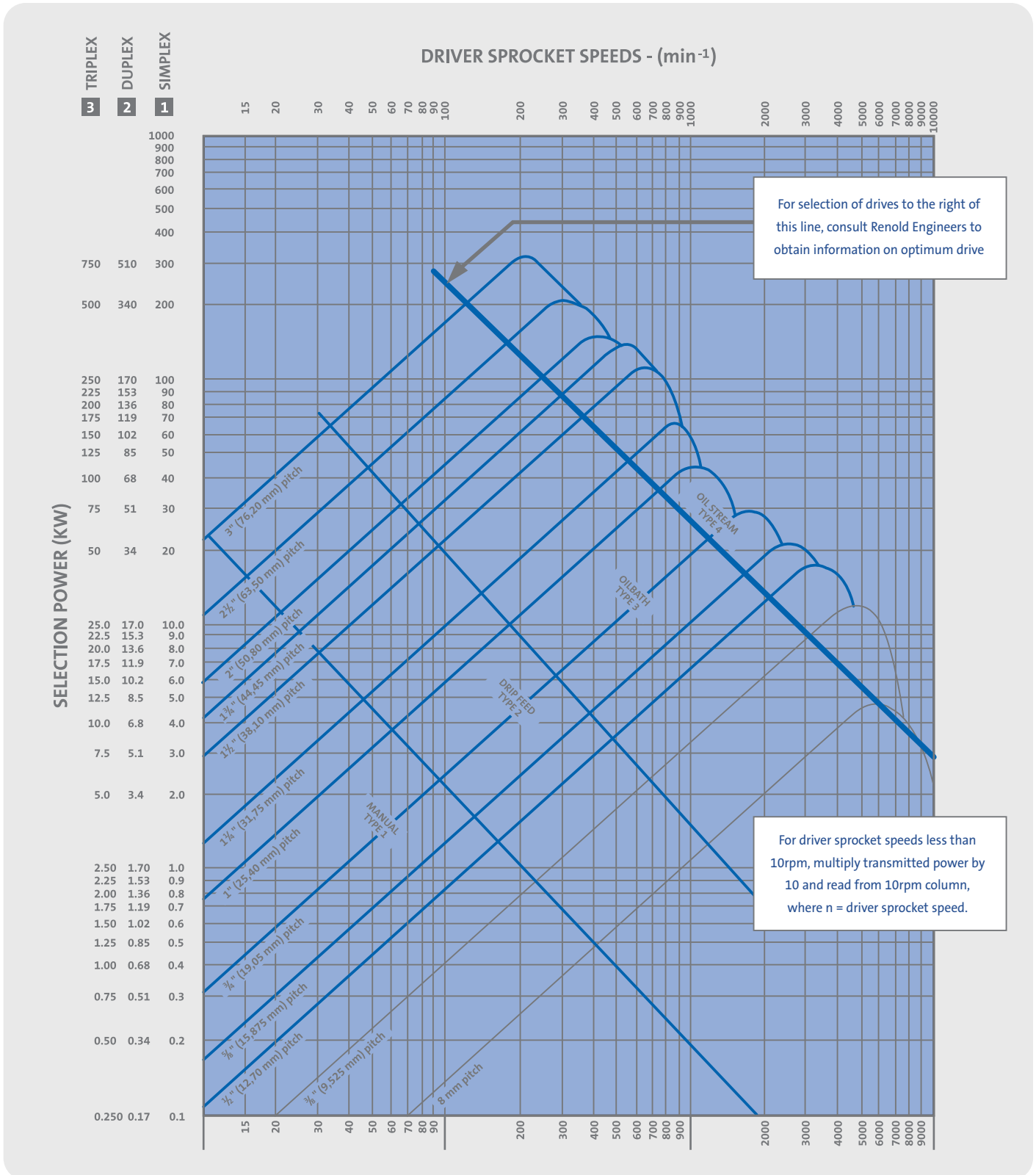

1 Kilowatt = 1.34 hp.

Renold Chain Designer Guide

ANSI Rating Chart

American Standard Chain Drives
Rating Chart using 19T Driver Sprocket

These ratings charts are based on standard Renold-brand transmission chain. For guidance on other chain types, go to www.renold.com/chainselector and use the exclusive Renold Chain Selector software.

Section 2

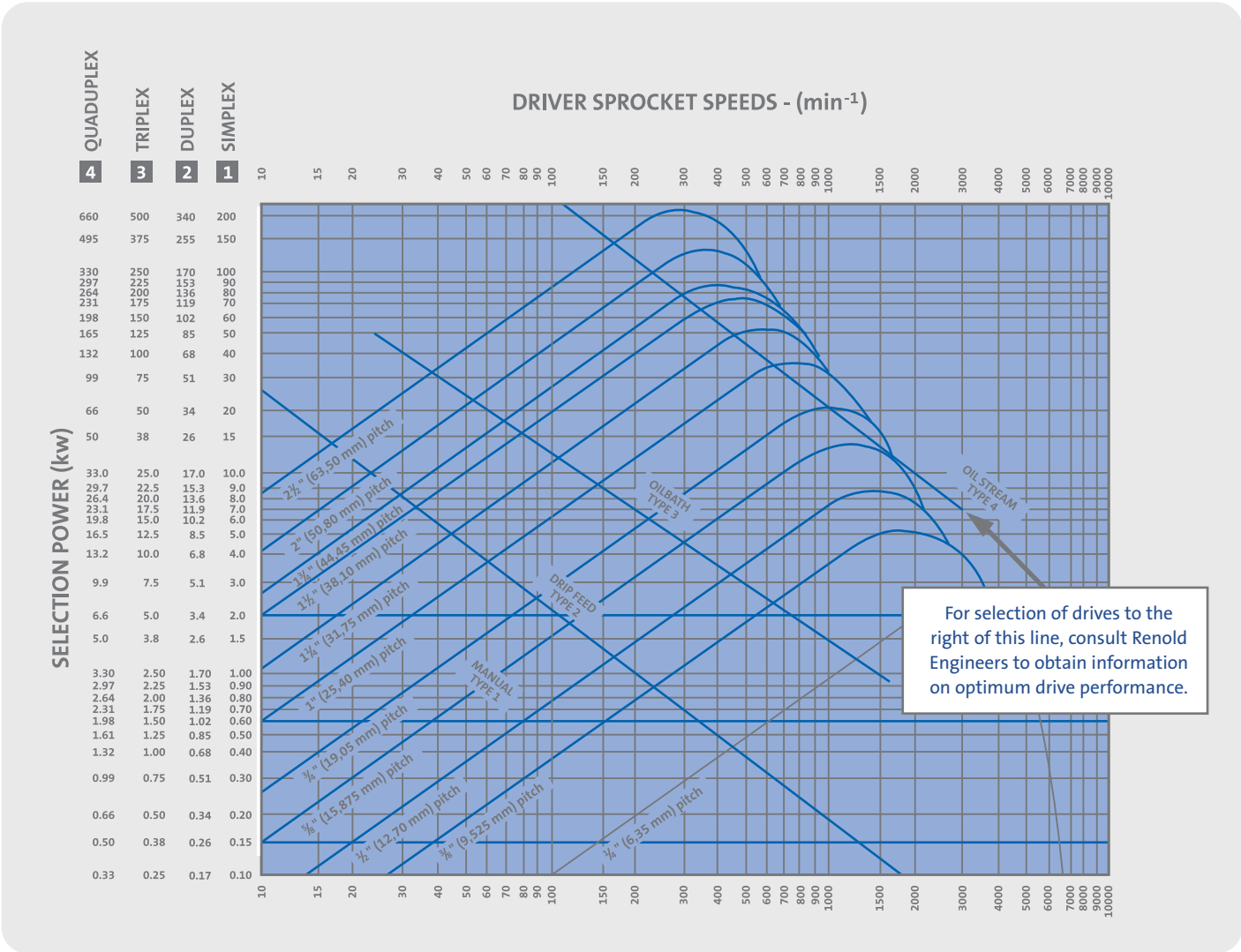

Transmission Equations

The following equations give the relationships between power, torque and velocity for various drive arrangements.

Torque $M_d = \frac{F_1 \times d_1}{2000}$ or $\frac{9550 \times P_r}{n_1}$ (Nm)

Power $P_r = \frac{M_d \times n_1}{9550}$ or $\frac{F_1 \times v}{1000}$ (kW)

Force $F_1 = \frac{1000 \times P_r}{v}$ or $\frac{2000 \times M_d}{d_1}$ (N)

Velocity $v = \frac{n_1 \times Z_1 \times P}{60000}$ (m/s)

Where:

- M_d = Torque of the driver sprocket Nm
- P_r = Power kW
- d_1 = Pitch circle diameter of the driver sprocket in mm
- n_1 = Driver sprocket speed rpm
- Z_1 = Number of teeth in the driver sprocket
- Z_2 = Number of teeth in the driven sprocket
- v = Linear speed of the chain m/s
- F_1 = Chain pull N
- P = Pitch of the chain mm

Centripetal Acceleration

Centripetal acceleration affecting parts of the chain engaged on the sprockets is determined by:

$$F_2 = qv^2 (N)$$

Where:

- F_2 = Force in N
- q = Mass of the chain in kg/m

From this formula we can see that at high speed, this force is not negligible and is the main reason for speed limitation.

Renold Chain Designer Guide

Chain Suspension Force

The force acting between one link and the next due to the mass of the chain is small and is internally balanced within the chain. This will do no more than cause the chain to adopt a sagging catenary shape between the sprockets.

Allowance will need to be made in the installation for the slightly different postures adopted by the chain between zero and maximum load.

Lubrication

Chain drives should be protected against dirt and moisture and be lubricated with good quality non-detergent mineral based oil. A periodic change of oil is desirable. Heavy oils and greases are generally too stiff to enter the chain working surfaces and should not be used.

Care must be taken to ensure that the lubricant reaches the bearing areas of the chain. This can be done by directing the oil into the clearances between the inner and outer link plates, preferably at the point where the chain enters the sprocket on the bottom strand.

The table below indicates the correct lubricant viscosity for various ambient temperatures.

| Ambient Temperature Celsius | Lubricant Rating SAE | Lubricant Rating BS4231 |
|-----------------------------|----------------------|-------------------------|
| -5 to +5 | 20 | 46 to 68 |
| 5 to 40 | 30 | 100 |
| 40 to 50 | 40 | 150 to 220 |
| 50 to 60 | 50 | 320 |

For the majority of applications in the above temperature range, a multigrade SAE 20/50 oil would be suitable.

Use of Grease

As mentioned above, the use of grease is not recommended. However, if grease lubrication is essential, the following points should be noted:

- Limit chain speed to 4 m/s.
- Applying normal greases to the outside surfaces of a chain only seals the bearing surfaces and will not work into them. This causes premature failure. Grease has to be heated until fluid and the chain is immersed and allowed to soak until all air bubbles cease to rise. If this system is used, the chains need regular cleaning and regreasing at intervals depending on the drives' power and speed. It should also be noted that temperatures above 80°C will cause damage to many greases and reduce their effectiveness.

Abnormal Ambient Temperatures

For elevated temperatures up to 250°C, dry lubricants such as colloidal graphite or MoS₂ in white spirit or poly-alkaline glycol carriers are most suitable.

Conversely, at low temperatures between -5°C and -40°C, special low temperature initial greases and subsequent oil lubricants are necessary. Lubricant suppliers will give recommendations.

Lubricating Methods

There are four basic methods for lubricating chain drives. The recommended lubrication method is based on the chain speed and power transmitted and can be found in the rating charts (see pages 105 and 106).

TYPE 1, Manual Operation

Oil is applied periodically with a brush or oil can, preferably once every 8 hours of operation. Volume and frequency should be sufficient to just keep the chain wet with oil and allow penetration of clean lubricant into the chain joints.

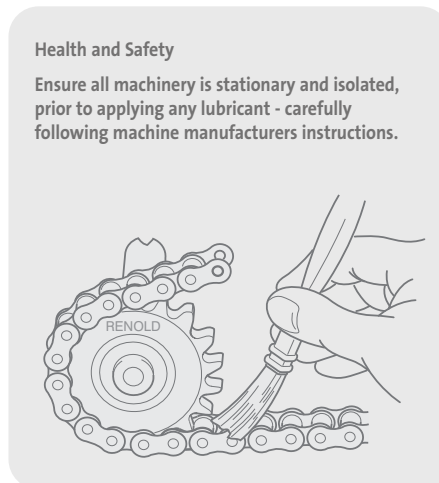

Applying lubricant by aerosol is also a satisfactory method, but it is important that the aerosol lubricant is of an approved type for the application, such as that supplied by Renold. This type of lubricant “winds” in to the pin/bush/roller clearances, resisting both the tendency to drip or drain when the chain is stationary and centrifugal “flinging” when the chain is moving.

TYPE 2, Drip Lubrication

Oil drips are directed between the link plate edges from a drip lubricator. Volume and frequency should be sufficient to allow penetration of lubricant into the chain joints.

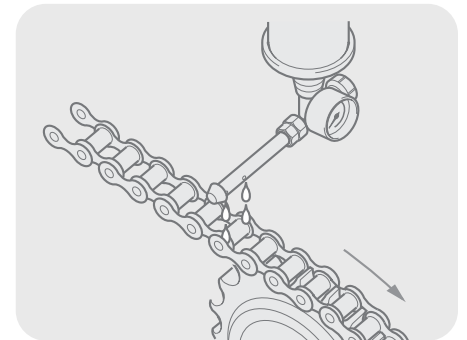

TYPE 3, Bath or Disc Lubrication

With oil bath lubrication the lower strand of chain runs through a sump of oil in the drive housing. The oil level should cover the chain at its lowest point whilst operating.

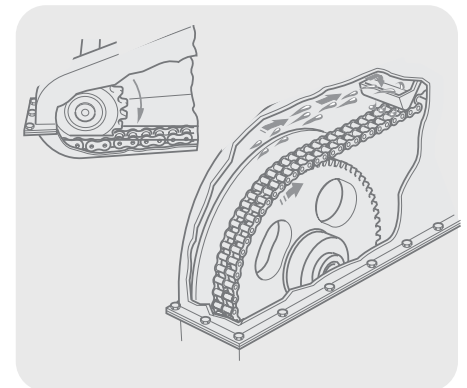

With slinger disc lubrication an oil bath is used, but the chain operates above the oil level. A disc picks up oil from the sump and deposits it on the chain by means of deflection plates. When such discs are employed they should be designed to have peripheral speeds between 180 to 2440 m/min.

Renold Chain Designer Guide

TYPE 4, Stream Lubrication

A continuous supply of oil from a circulating pump or central lubricating system is directed onto the chain. It is important to ensure that the spray holes from which the oil emerges are in line with the chain edges. The spray pipe should be positioned so that the oil is delivered onto the chain just before it engages with the driver sprocket.

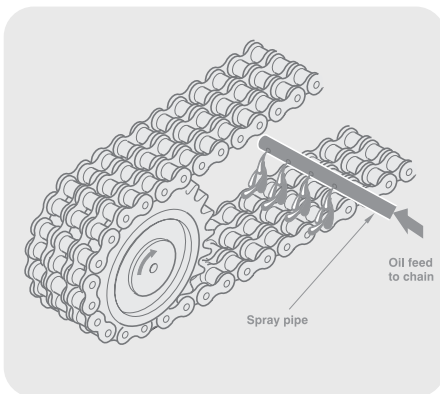

This ensures that the lubricant is centrifuged through the chain and assists in cushioning roller impact on the sprocket teeth. Stream lubrication also provides effective cooling and impact damping at high speeds.

Effect of Temperature

An important factor to control in a drive system is the chain and chaincase temperatures during operation. Depending on the severity of the drive service, continuity of use, etc., special attention to the lubrication method may be required.

Chain temperatures above 100°C should be avoided if possible due to lubrication limitations, although chain can generally give acceptable performance up to around 250°C in some circumstances. A way of improving the effectiveness of the lubrication and its cooling effect is to increase the oil volume (up to 4.5 litres per minute per chain strand) and incorporate a method of external cooling for the oil.

Lifting Applications

This section covers applications such as lifting and moving, where the loads involved are generally static. Obviously, dynamic loads are also involved in most applications and the designer needs to take due consideration of these. The machinery designer should also refer to DTI Publication INDY J1898 40M which summarises legislation in place from 1st January 1993 and 1st January 1995 regarding machinery product standards.

Chain for lifting applications falls into 2 main categories:

- Leaf Chains.
- Bush/Roller Chains.

Leaf Chain

Leaf chain is generally used for load balancing type lifting applications as illustrated below. They must be anchored at either end since there is no means of geared engagement in the chain itself.

Safety Factors

A safety factor of 7:1 is normal for steady duty reciprocating motion, e.g. fork lift trucks. For medium shock loads, 9:1 and for heavy shock loads, 11:1.

Operating Speed

Applications should not exceed a maximum chain speed of 30 metres/min.

Applications

1. Machine Tools - Planers, Drills, Milling Heads, Machine Centres.

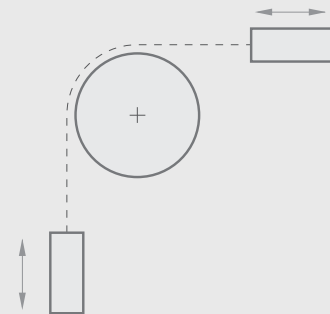

2. Fork Lift Trucks, Lifts, Hoists.

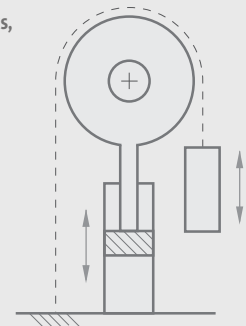

3. Counterweight Balances - Jacks, Doors, Gates etc.

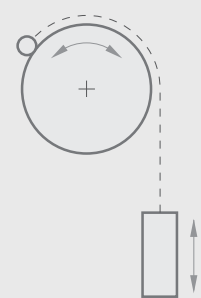

Renold Chain Designer Guide

Bush and Roller Chains

Bush and roller chains can be used for lifting and moving purposes and have the advantage over leaf chain in that they may be geared into a suitable driving sprocket. Roller chain has a better wear resistance than leaf chain and may be used at higher speeds.

Safety Factors

Applications vary widely in the nature of loads applied and it is therefore recommended that factors of safety are applied which allow for some degree of abuse.

- A factor of safety of 8:1 in non-passenger applications
- A factor of safety of 10:1 in passenger applications

Lower factors of safety than these may be used (except for passenger applications), where careful consideration of the maximum loads and health and safety implications have been made. For comments on this see the section 'Influences on chain life'.

Operating Speeds

Applications should not normally exceed a maximum chain speed of 45 metres/min. For speeds higher than this, consider selection as if the chain were in a power transmission application converting the chain load to power using the following formula:

$$\text{POWER} = FV \text{ (kW)}$$

Where:

F = Load kN

V = Velocity of chain (m/s)

Then apply selection power factors as shown in step 2 of 'DRIVE SELECTION'.

Calculate equivalent RPM by using the smallest sprocket in the system where speed = $\frac{60000V}{PZ}$

Where:

P = Chain Pitch (mm)

Z = No of Teeth in Sprocket

Select lubrication methods also from the selection chart.

ANSI Xtra Range

Transmission chain is also available in heavy duty versions of the ANSI standard range of chain.

These chains are suitable where frequent or impulsive load reversals are involved. Typical applications are in primary industries such as mining, quarrying, rock drilling, forestry and construction machinery.

In order to accommodate these higher fatigue inducing loads, material for inner and outer plates is increased in thickness by approximately 20%.

This modification does not improve the tensile strength since the pin then becomes the weakest component. However, heavy duty chains with higher tensile strength are available. This is achieved by through hardening instead of case hardening the pin, but unfortunately this action reduces wear performance due to the lower pin hardness.

Renold ANSI XTRA chains are available as follows:

- XTRA H RANGE - Thicker plates
- XTRA V RANGE - Through hardened pins
- XTRA HV RANGE - Thicker plates and through hardened pins

The H and HV chains are not suitable or appropriate for high speed transmission applications.

The following points should also be noted:

- The V range of chains are totally interchangeable with standard ANSI chain.
- Simple chains of standard, H or HV designs all have identical gearing dimensions and therefore can operate on the same sprockets as for standard chains. The thicker plates will require a larger chain track and it may be desirable to use sprockets with heat treated teeth. Multiplex chain requires an increased transverse pitch of the teeth but other gearing dimensions are the same.
- The only reason to use H or HV chains is where fatigue life is a problem. We do not make any cranked (offset) links or slip-fit connecting links for this range, since these have a lower fatigue resistance.
- Detachable (cottered) versions can be produced if required as could triplex or wider chains.

Influences on Chain Life

Factors of Safety

All Renold chain is specified by its minimum tensile strength. To obtain a design working load it is necessary to apply a 'Factor of safety' to the breaking load. However, before considering this, the following points should be noted:

- Most chain side plates are manufactured from low to medium carbon steel and are sized to ensure they have adequate strength and also ductility to resist shock loading.
- These steels have yield strengths around 65% of their ultimate tensile strength. What this means is that if chains are subjected to loads of greater than this, depending upon the material used in the side plates, then permanent pitch extension will occur.
- Most applications are subjected to transient dynamic loads well in excess of the maximum static load and usually greater than the designer's estimate.
- Motors, for example, are capable of up to 200% full load torque output for a short period.

Renold Chain Designer Guide

The consequences of these points are that chain confidently selected with a factor of safety of 8:1 on breaking load is, in effect, operating with a factor of safety of around 5:1 on yield and much less than this when the instantaneous overload on the drive is considered.

| Safety Factors | | Safety Critical |
|----------------|--------------------|-----------------|
| 12 | Harsh Environments | |
| 11 | | |
| 10 | Passenger Lifts | |
| 9 | | |
| 8 | Transmission | |
| 7 | High Cycle Lifting | |
| 6 | Low Cycle Lifting | |
| 5 | | |
| 4 | | |
| 3 | | |
| 2 | | |
| 1 | Not Normally Used | |

Axial breaking force/max working load

A further consideration when applying a factor of safety to a chain application is the required chain life.

| Factor Simple | Factor Multiplex | Cycles Maximum | Type of Application |
|---------------|------------------|----------------|---|
| 5.0 | 6.0 | 1,000,000 | Dynamic load does not exceed working load |
| 6.0 | 7.2 | 2,000,000 | |
| 8.0 | 8.0 | 8,000,000 | Dynamic loads can occasionally exceed working load by 20% |
| 10.0 | 10.0 | 8,000,000 | All passenger lifts |

In a properly maintained application a life of 8,000,000 cycles or 15,000 hours, whichever comes first, is normal. Wear will be the usual mode of failure.

In applications where low factors of safety are required, the life will reduce accordingly.

The maximum working load is obtained by dividing the chain minimum tensile strength by the factor of safety.

The table below gives a rough indication of life for various factors of safety.

It should be noted that at factors below 8:1, bearing pressures increase above the maximum recommended, with the result that increased wear will arise unless special attention is taken with lubrication, e.g.:

- More frequent lubrication.
- Higher performance lubricants.
- Better methods of applying lubrication.

Important Note

For factors of 5:1 the resulting bearing pressure is 50% higher than recommended and chain working under these conditions will wear prematurely, whatever type of lubrication regime is used.

Harsh Environments

In anything other than a clean and well lubricated environment, the factor of safety should be adjusted if some detriment to the working life of the chain is to be avoided. Low temperatures will also decrease working life, especially if shock loads are involved.

The following tables give a general guide to the appropriate safety factors for different applications for a target life of 8,000,000 cycles.

| Lubrication | Cleanliness Clean | Cleanliness Moderately Clean | Cleanliness Dirty/Abrasive |
|-------------|-------------------|------------------------------|----------------------------|
| Regular | 8 | 10 | 12 |
| Occasional | 10 | 12 | 14 |
| None | 12 | 12 | 14 |

| Lubrication | Temp. °C +10 to 150 | Temp. °C 150 to 200 | Temp. °C 200 to 300 |
|-------------|---------------------|---------------------|---------------------|
| Regular | 8 | 10 | 12 |
| Occasional | 10 | 12 | 14 |
| None | 12 | 12 | 14 |

| Temperature (°C) | Load Regime Smooth | Load Regime Moderate Shocks | Load Regime Heavy Shocks |
|------------------|--------------------|-----------------------------|--------------------------|
| +10° to +150° | 8 | 11 | 15 |
| 0° to +10° | 10 | 15 | 19 |
| -20° to zero° | 12 | 20 | 25 |
| -40° to -20° | 15 | 25 | 33 |

Chain Extension

When designing lifting applications it can be useful to know how much a chain will extend under a given load.

The approximate elongation of a chain under a given load can be measured by using the following formulae.

- Simplex chain $\Delta L = \frac{(14.51) \times 10^{-5} \times L}{p^2} \times F_1$
- Duplex Chain $\Delta L = \frac{(9.72) \times 10^{-5} \times L}{p^2} \times F_1$
- Triplex Chain $\Delta L = \frac{(7.26) \times 10^{-5} \times L}{p^2} \times F_1$

Where:

- ΔL = Change in chain length (mm)
- L = Original length of the chain (mm)
- P = Pitch of the chain (mm)
- F1 = Average load in the chain

Renold Chain Designer Guide

Matching of Chain

Any application in which two or more strands of transmission chain are required to operate side by side in a common drive, or conveying arrangement, may involve the need for either pairing or matching. Such applications generally fall into one of the following categories :

Length Matching for Conveying and Similar Applications

Wherever length matching of transmission chain is necessary it is dealt with as follows:

- The chains are accurately measured in handling lengths between 3m to 8m as appropriate and then selected to provide a two (or more) strand drive having overall length uniformity within close limits. However, such length uniformity will not necessarily apply to any intermediate sections along the chains, but the actual length of all intermediate sections, both along and across the drive, will not vary more than our normal manufacturing limits. However, adapted transmission chains are usually manufactured to specific orders which are generally completed in one production run so that it is reasonable to assume that length differences of intermediate sections will be small.
- Chains are supplied in sets which are uniform in overall length within reasonably fine limits and will be within our normal manufacturing limits. It should be noted that chain sets supplied against different orders at different times may not have exactly the same lengths to those supplied originally, but will vary by no more than our normal tolerance of 0.0%, +0.15%.

Pitch Matching Transmission Drive Chains

Pitch matched chains are built up from shorter subsections (usually 300 to 600mm lengths) which are first measured and then graded for length. All subsections in each grade are of closely similar length and those forming any one group across the set of chains are selected from the same length grade.

The requisite number of groups are then connected to form a pitch matched set of chains, or alternatively, if this is too long for convenient handling, a set of handling sections for customer to assemble as a final set of pitch matched chain. Suitable tags are fixed to the chains to ensure they are connected together in the correct sequence.

Identification of Handling Lengths

Long chains are made up in sections, each section being numbered on end links. Sections should be so joined up that end links with similar numbers are connected. Where chains are to run in sets of two or more strands, each strand is stamped on end links of each section with a letter, in addition to being numbered. Correct consecutive sections for each strand must be identified from the end links and joined up as indicated.

By these means, the actual length of any intermediate portion of one strand (as measured from any one pitch point to any other) will correspond closely with that of the transversely equivalent portion on the other strands, generally within 0.05mm, depending on the chain pitch size.

| | Handling Length 1 | Handling Length 2 | Handling Length 3 |
|----------|-------------------|-------------------|-------------------|
| A Strand | A-A1 | A1-A2 | A2-A3 |
| B Strand | B-B1 | B1-B2 | B2-B3 |
| C Strand | C-C1 | C1-C2 | C2-C3 |

Pitch Matching Adapted Transmission Chains (when attachments are fitted to chains)

With the sole exception of extended bearing pins, it is not possible to match the pitch of holes in attachments themselves to within very fine limits, due to the additional tolerances to be contended with (bending, holing, etc.).

Colour Coding

For customers who wish to match their chains, perhaps in order to fit special attachments in situ, Renold colour code short lengths of chain within specified tolerance bands. These will normally be RED, YELLOW or GREEN paint marks to indicate lower, mid and upper thirds of the tolerance band. For even finer tolerance bands additional colours can be used, but normally a maximum of five colours will be more than adequate.

COLOUR

| | |
|--------|------------|
| RED | 0.05% |
| YELLOW | 0.10% |
| GREEN | 0.15% |
| BLUE | For Finer |
| WHITE | Tolerances |

To Measure Chain Wear

A direct measure of chain wear is the extension in excess of the nominal length of the chain. The chain wear can therefore be ascertained by length measurement in line with the instructions given below.

- Lay the chain, which should terminate at both ends with an inner link (part No 4), on a flat surface, and, after anchoring it at one end, attach to the other end a turnbuckle and a spring balance suitably anchored.
- Apply a tension load by means of the turnbuckle amounting to:

| | |
|---------------|---------------|
| SIMPLEX CHAIN | P2 x 0.77 (N) |
| DUPLEX CHAIN | P2 x 1.56 (N) |
| TRIPLEX CHAIN | P2 x 2.33 (N) |

Where P is the pitch in mm.

Renold Chain Designer Guide

In the case of double pitch chains (e.g. chains having the same breaking load and twice the pitch) apply measuring loads as for the equivalent short pitch chains.

As an alternative, the chain may be hung vertically and the equivalent weight attached to the lower end.

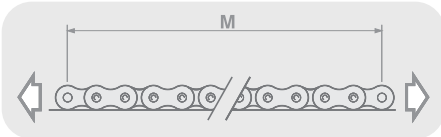

- Measure length 'M' (see diagram above) in millimetres from which the percentage extension can be obtained from the following formula:

$$\text{Percentage Extension} = \frac{M - (N \times P)}{N \times P} \times 100$$

Where N = number of pitches measured
Where P = pitch

- As a general rule, the useful life of the chain is terminated and the chain should be replaced when extension reaches 2 per cent (1 per cent in the case of double pitch chains). For drives with no provision for adjustment, the rejection limit is lower, dependent upon the speed and layout. A usual figure is between 0.7 and 1.0 per cent extension.

Renold Chain Wear Guide

A simple-to-use chain wear guide is available from Renold Chain for most popular sizes of chain pitch. Please contact your Sales Office for details.

Repair and Replacement

Sprockets

Examination of both flanks will give an indication of the amount of wear which has occurred. Under normal circumstances this will be evident as a polished worn strip about the pitch circle diameter of the sprocket tooth.

If the depth of this wear 'X' has reached an amount equal to 10% of the 'Y' dimension, then steps should be taken to replace the sprocket. Running new chain on sprockets having this amount of tooth wear will cause rapid chain wear.

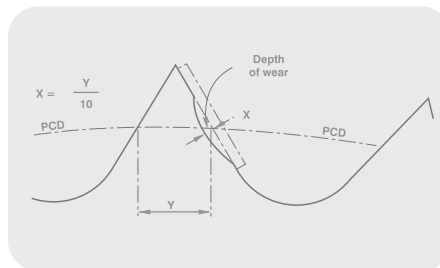

It should be noted that in normal operating conditions, with correct lubrication the amount of wear 'X' will not occur until several chains have been used.

Chain

Chain repair should not as a rule be necessary. A correctly selected and maintained chain should gradually wear out over a period of time (approximately 15000 hours), but it should not fail. Please refer to the Installation and Maintenance section, which gives an indication of the service life remaining.

If a transmission chain sustains damage due to an overload, jam-up, or by riding over the sprocket teeth, it should be carefully removed from the drive and given a thorough visual examination. Remove the lubricating grease and oil to make the job easier.

Depending on the damage, it may be practicable to effect temporary repairs using replacement links. It is not, however, a guarantee that the chain has not been overstressed and so made vulnerable to a future failure. The best policy, therefore, is to remove the source of trouble and fit a new chain. This should be done for the following reasons.

1. The cost of down time to the system or machine can often outweigh the cost of replacing the chain.
2. A new or even used portion of chain or joints assembled into the failed chain will cause whipping and load pulsation. This can, and probably will, produce rapid failure of the chain and will accelerate wear in both the chain and its sprockets.

If a chain has failed two or more times, it is certain the chain will fail again in time. If no replacement is immediately available, repair the chain, but replace it at the earliest opportunity.

Chain Adjustment

To obtain full chain life, some form of chain adjustment must be provided, preferably by moving one of the shafts. If shaft movement is not possible, an adjustable jockey sprocket engaging with the unloaded strand of the chain is recommended. Generally the jockey should have the same number of teeth as the driver sprocket and care should be taken to ensure the speed does not exceed the maximum shown in the rating charts (see pages 105 and 106).

The chain should be adjusted regularly so that, with one strand tight, the slack strand can be moved a distance 'A' at the mid point (see diagram below). To cater for any eccentricities of mounting, the adjustment of the chain should be tried through a complete revolution of the large sprocket.

A = Total movement

C = Horizontal Centre Distance

$$\text{Total movement 'A' (mm)} = \frac{C \text{ (mm)}}{K}$$

Where K = 25 for smooth drives
50 for shock drives

For vertical drives please consult the installation and maintenance section, which gives more details on chain adjustment.

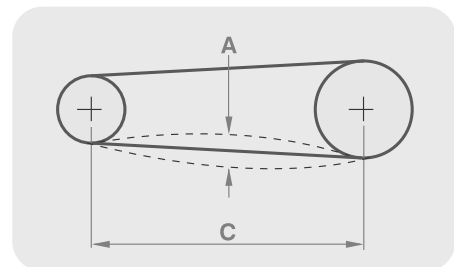

Renold Chain Designer Guide

Design Ideas

A variety of applications

Conveying, Indexing, Lifting and Pulling, Power Transmission, Timing.

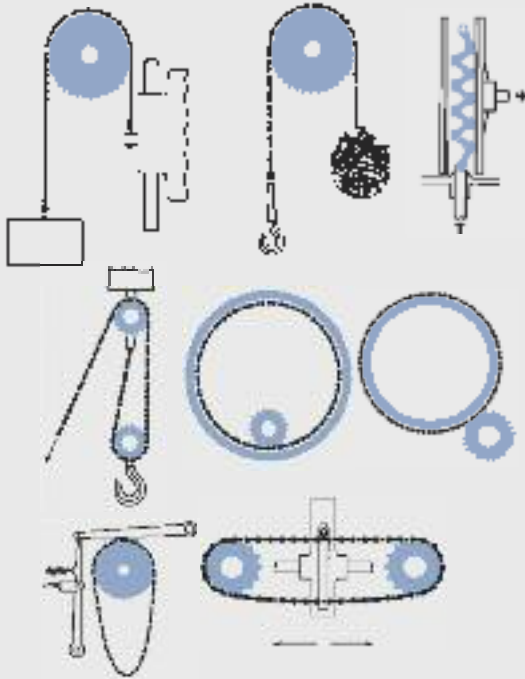

A variety of industries

Aircraft, Automotive, Marine, Mechanical Handling, Motorcycle, Nuclear, Oilfield.

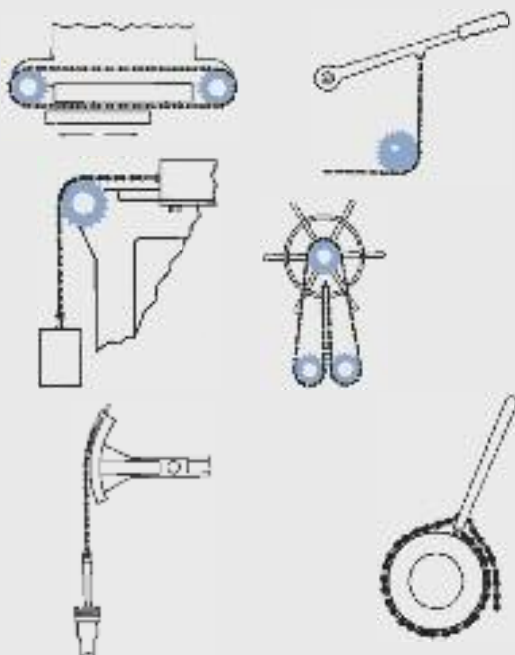

Table of PCD Factors

To obtain pitch circle diameter of any sprocket with 9 to 150 teeth, multiply chain pitch by appropriate factor.

e.g. The PCD of a 38T sprocket of 3/4" (19.05mm) pitch
 = 19.05 x 12.110 = 230.70mm

| Number of teeth | PCD Factor | Number of teeth | PCD Factor | Number of teeth | PCD Factor |
|-----------------|------------|-----------------|------------|-----------------|------------|
| 9 | 2.924 | 57 | 18.153 | 105 | 33.428 |
| 10 | 3.236 | 58 | 18.471 | 106 | 33.746 |
| 11 | 3.549 | 59 | 18.789 | 107 | 34.064 |
| 12 | 3.864 | 60 | 19.107 | 108 | 34.382 |
| 13 | 4.179 | 61 | 19.426 | 109 | 34.701 |
| 14 | 4.494 | 62 | 19.744 | 110 | 35.019 |
| 15 | 4.810 | 63 | 20.062 | 111 | 35.337 |
| 16 | 5.126 | 64 | 20.380 | 112 | 35.655 |
| 17 | 5.442 | 65 | 20.698 | 113 | 35.974 |
| 18 | 5.759 | 66 | 21.016 | 114 | 36.292 |
| 19 | 6.076 | 67 | 21.335 | 115 | 36.610 |
| 20 | 6.392 | 68 | 21.653 | 116 | 36.928 |
| 21 | 6.709 | 69 | 21.971 | 117 | 37.247 |
| 22 | 7.027 | 70 | 22.289 | 118 | 37.565 |
| 23 | 7.344 | 71 | 22.607 | 119 | 37.883 |
| 24 | 7.661 | 72 | 22.926 | 120 | 38.202 |
| 25 | 7.979 | 73 | 23.244 | 121 | 38.520 |
| 26 | 8.296 | 74 | 23.562 | 122 | 38.838 |
| 27 | 8.614 | 75 | 23.880 | 123 | 39.156 |
| 28 | 8.931 | 76 | 24.198 | 124 | 39.475 |
| 29 | 9.249 | 77 | 24.517 | 125 | 39.793 |
| 30 | 9.567 | 78 | 24.835 | 126 | 40.111 |
| 31 | 9.885 | 79 | 25.153 | 127 | 40.429 |
| 32 | 10.202 | 80 | 25.471 | 128 | 40.748 |
| 33 | 10.520 | 81 | 25.790 | 129 | 41.066 |
| 34 | 10.838 | 82 | 26.108 | 130 | 41.384 |
| 35 | 11.156 | 83 | 26.426 | 131 | 41.703 |
| 36 | 11.474 | 84 | 26.744 | 132 | 42.021 |
| 37 | 11.792 | 85 | 27.063 | 133 | 42.339 |
| 38 | 12.110 | 86 | 27.381 | 134 | 42.657 |
| 39 | 12.428 | 87 | 27.699 | 135 | 42.976 |
| 40 | 12.746 | 88 | 28.017 | 136 | 43.294 |
| 41 | 13.063 | 89 | 28.335 | 137 | 43.612 |
| 42 | 13.382 | 90 | 28.654 | 138 | 43.931 |
| 43 | 13.700 | 91 | 28.972 | 139 | 44.249 |
| 44 | 14.018 | 92 | 29.290 | 140 | 44.567 |
| 45 | 14.336 | 93 | 29.608 | 141 | 44.885 |
| 46 | 14.654 | 94 | 29.927 | 142 | 45.204 |
| 47 | 14.972 | 95 | 30.245 | 143 | 45.522 |
| 48 | 15.290 | 96 | 30.563 | 144 | 45.840 |
| 49 | 15.608 | 97 | 30.881 | 145 | 46.159 |
| 50 | 15.926 | 98 | 31.200 | 146 | 46.477 |
| 51 | 16.244 | 99 | 31.518 | 147 | 46.795 |
| 52 | 16.562 | 100 | 31.836 | 148 | 47.113 |
| 53 | 16.880 | 101 | 32.154 | 149 | 47.432 |
| 54 | 17.198 | 102 | 32.473 | 150 | 47.750 |
| 55 | 17.517 | 103 | 32.791 | | |
| 56 | 17.835 | 104 | 33.109 | | |

Renold Chain Designer Guide

Simple Point to Point drives - Example One

The following worked examples give simple step-by-step guidance on selecting various types of chain drive systems. Renold technical staff are available to advise on any chain selection problems. For details of transmission equations see page 106.

Example One Rotary Pump Drive

GIVEN:

- Pump speed 360 rpm
- Power absorbed 7.5 kW
- Driver Electric motor at 1440 rpm
- Constraints Centre distance approx 458 mm Adjustment by shaft movement

1 - Selection Parameters

- Use $Z_1 = 19T$
- No polygonal effect
- Satisfactory for smooth drives

Calculate the drive ratio as follows:

$$\text{Drive Ratio} = i = \frac{Z_2}{Z_1} = \frac{N_2}{N_1} = \frac{1440}{360} = 4$$

Therefore the driven number of teeth

$$Z_2 = 4 \times Z_1 = 4 \times 19 = 76T$$

2 - Selection Factors

Application Factor $f_1=1$ (driver and driven sprockets smooth running)

$$\text{Tooth Factor} \quad f_2 = \frac{19}{19} = 1$$

$$\text{Selection Power} = 7.5 \times 1 \times 1 = 7.5 \text{ kW}$$

3 - Select Chain

The chain can now be selected using charts 3 and 4 and cross referencing power to speed, giving the following possibilities:

- 0.5" BS Simplex
(Approx 81% of rated Capacity)
- 0.375" BS Duplex
(Approx 98% of rated Capacity)
- 0.5" ANSI Simplex
(Approx 83% of rated Capacity)
- 0.375" ANSI Duplex
(Approx 84% of rated Capacity)

0.375" ANSI Duplex chain is unsuitable as it is a bush chain.

Note - The approximate percentage of rated capacity is calculated by dividing the selection power at 1440 rpm by the chains maximum capacity at 1440 rpm.

For this example we will choose 0.5" European Simplex

4 - Installation Parameters

LUBRICATION - European Chain Rating Chart (see page 105) clearly indicates the chain needs OILBATH lubrication. The chain will need to be enclosed and run in a sump of oil.

We now calculate the CHAIN LENGTH

$$L = \frac{Z_1 + Z_2}{2} + \frac{2C}{P} + \frac{P}{C} \left(\frac{Z_2 - Z_1}{2\pi} \right)^2$$

$$L = \frac{19 + 76}{2} + \frac{2 \times 458}{12.7} + \frac{12.7}{458} \left(\frac{76 - 19}{2\pi} \right)^2 = 121.9$$

Round up to the nearest number of even pitches i.e. 122.

5 - Centre Distance Calculation

The centre distance of the drive can now be calculated using the formula shown below:

$$C = \frac{P}{8} \left[2L - Z_2 - Z_1 + \sqrt{(2L - Z_2 - Z_1)^2 - \frac{\pi}{3.88} (Z_2 - Z_1)^2} \right]$$

$$C = \frac{12.7}{8} \left[(2 \times 122) - 76 - 19 + \sqrt{((2 \times 122) - 76 - 19)^2 - \frac{\pi}{3.88} \times (76 - 19)^2} \right]$$

$$C = 458.6 \text{ mm}$$

6 - Adjustment

Provide for chain wear of 2% or two pitches, whichever is smaller, in this case, $(122 \times 1.02) - 122 = 2.44$ pitches.

Therefore use 2 pitches and recalculate using:

$$L = 124 \text{ in the above equation. This gives}$$

$$C = 471.7 \text{ mm}$$

i.e. total adjustment of 13.1mm.

Note that in practice, some negative adjustment will facilitate assembly and will be essential if it is intended to assemble chain which is pre-joined into an endless loop.

7 - Other Data

$$\text{Chain Velocity} = \frac{N.P. \cdot Z_1}{60000} = \frac{1440 \times 12.7 \times 19}{60000} = 5.79 \text{ m/s}$$

$$\text{Load in chain due to power transmitted} = \frac{Q \cdot 1000}{V}$$

(Where Q = Selection power (kw))

$$\frac{7.5 \times 1000}{5.79} = 1295 \text{ N}$$

$$\text{Load in chain due to centripetal acceleration} = \text{Chain mass/metre} \times \text{Velocity}^2$$

$$= 0.68 \times 5.79^2$$

$$= 23 \text{ N}$$

$$\text{Total chain working load} = 1318 \text{ N}$$

Note the load in the chain due to centripetal acceleration becomes much more significant at higher speeds since the square of the chain velocity is in the equation.

$$\text{Chain axial breaking force} = 19000 \text{ N}$$

$$\text{Chain safety factor} = \frac{19000}{1318} = 14.4$$

$$\text{Chain bearing area} = 50 \text{ mm}^2$$

$$\text{Bearing Pressure} = \frac{\text{WORKING LOAD}}{\text{BEARING AREA}} = \frac{1318}{50} = 26.36 \text{ N/mm}^2$$

Renold Chain Designer Guide

Simple Point to Point drives - Example Two

The following worked examples give simple step-by-step guidance on selecting various types of chain drive systems. Renold technical staff are available to advise on any chain selection problems. For details of transmission equations see page 106.

Example Two 4-Cylinder Compressor

GIVEN:

- Pump speed 250 rpm
- Power absorbed 250 kW
- Driver Electric motor at 960 rpm
- Constraints Centre distance approx 1500 mm

1 - Selection Parameters

Use a 25T sprocket for an impulsive drive (see page 101) selection of drive ratio and sprockets.

$$\text{Drive Ratio} = \frac{Z_2}{Z_1} = \frac{N_2}{N_1} = \frac{960}{250} = 3.84$$

Number of teeth $Z_2 = 3.84 \times Z_1 = 3.84 \times 25 = 95T$

2 - Selection Factors

Application Factor $f_1 = 1.5$ (driver and driven sprocket medium impulsive)

$$\text{Tooth Factor } f_2 = \frac{19}{Z_1} = \frac{19}{25} = 0.76$$

Selection Power = Transmitted power $\times f_1 \times f_2$ (kW)

$$\text{Selection Power} = 250 \times 1.5 \times 0.76 = 285\text{kW}$$

3 - Select Chain

The chain can now be selected using European Chain Rating Chart (see page 105) by cross referencing the power (285kW on the vertical axis) and speed (960 rpm on the horizontal axis).

Two matched strands of 1.25" pitch European triplex chains could be used with a heat treated 25 tooth steel driver and a 95 tooth driven sprocket to give a drive ratio of 3.8 to 1.

4 - Installation Parameters

LUBRICATION - European Chain Rating Chart (see page 105) clearly shows that an oilstream system is required on this drive. The chain should run in an enclosure with a pump and sump arrangement.

We will now calculate the CHAIN LENGTH

$$L = \frac{25+95}{2} + \frac{2 \times 1500}{31.75} + \frac{31.75 \left(\frac{95-25}{2\pi} \right)^2}{1500} = 157.12$$

Round up to the nearest number of even pitches i.e. 158

5 - Centre Distance Calculation

The centre distance of the drive can now be calculated using the standard formula below: = 1514.44mm

$$C = \frac{31.75}{8} \left[\left((2 \times 158) - 95 - 25 \right) + \sqrt{\left((2 \times 158) - 95 - 25 \right)^2 - \frac{\pi}{3.88} (95 - 25)^2} \right]$$

6 - Adjustment

$$\text{Chain Velocity} = \frac{960 \times 31.75 \times 25}{60000} = 12.7\text{m/s}$$

$$\text{Load in the Chain} = \frac{285 \times 1000}{12.7} = 22440\text{ N}$$

Load in the chain due to centripetal acceleration = $11.65 \times 2 \times 12.7 \times 12.7 = 3758\text{ N}$

Total chain WORKING LOAD = 26027 N

$$\text{Bearing Pressure} = \frac{\text{WORKING LOAD}}{\text{BEARING AREA}} = \frac{23272}{885 \times 2} = 14.7\text{N/mm}^2$$

$$\text{Chain Safety Factor} = \frac{\text{BREAKING LOAD}}{\text{WORKING LOAD}} = \frac{294200 \times 2}{26027} = 22.6$$

Multi-Shaft Drives

Shafts in series

This arrangement shows the driving of live roller conveyors.

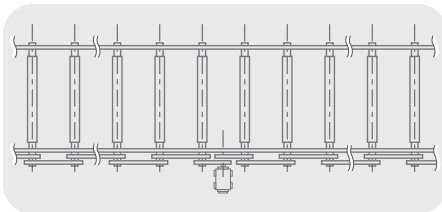

The choice of the chain is based on the slipping torque between the rollers and the material to be transported. The safety factor to be applied for this type of drive is typically:

Safety factor = 5 for one direction drives

Safety factor = 8 for reversible drives

Every roller except the last comprises two simple sprockets, or one special sprocket to be used with two simple chains. At low speeds or in reversible drives, sprockets with hardened teeth should be used.

Roller conveyors with less than 10 rollers can be driven from one of the ends of the track. When the number of rollers is higher, it is recommended that the driving arrangement is in the middle of the conveyor in order to have a better distribution of the power and the highest overall efficiency.

If we assume that a drive operating under ideal conditions such as a clean environment and correct lubrication achieves an efficiency of R%, then the overall efficiency of a roller conveyor with X rollers will be:

$$100 \left(\frac{R}{100} \right)^X = \frac{R^X}{100^{(X-1)}}$$

If the individual drive efficiency R is equal to 98%, then the drive of a roller conveyor with 30 rollers will therefore only have an overall efficiency of 55%

Consequently, it is recommended that no more than 30 rollers per drive are used. For roller conveyors with more than 30 rollers, use multiple drives.

The drive should be able to develop a torque corresponding to the slipping torque of the loaded rollers.

Renold Chain Designer Guide

Simple Point to Point drives - Example Three

The following worked examples give simple step-by-step guidance on selecting various types of chain drive systems. Renold technical staff are available to advise on any chain selection problems. For details of transmission equations see page 106.

Example Three

GIVEN:

- Moving a stack of steel plates.
- 20 rollers with a diameter of 150mm.
- Shafts with a diameter of 60mm on ball bearings.
- Weight of one roller 1900N.
- There are two stacks on the conveyor at any one time.
- One stack weighs 17500N with a length of 1500mm.
- Total nett load : 35000N (two stacks).
- Centre distance of the rollers : 300mm.
- Linear speed : 15 m/min.
- PCD of the sprockets : 140mm.
- Impulsive load : 30 starts per hour, in one direction.

1 - Assumptions

- A drive is placed in the middle with 10 rollers on each side
- The rolling resistance of the rollers is 0.05
- The friction resistance between the rollers and the load is 0.25
- The efficiency per drive is 98%

2 - Selection Calculations

Every stack of steel is 17500 N and is conveyed by

$$\frac{\text{Stack length}}{\text{Centre distance of rollers}} = \frac{1500}{300} = 5 \text{ Rollers}$$

or 10 rollers for the total nett load.

If a nett load of 35000 N is added to the total weight of 10 bearing rollers (19000 N), then this gives a gross load of 54000 N.

The tangential force for 10 rollers is : 54000 x 0.05 = 2700 N and the corresponding torque is:

$$F \times d (\text{force} \times \text{distance}) = 2700 \times \frac{0.06}{2} = 81\text{Nm}$$

Note: Where d = shaft diameter
For each group of 10 rollers the efficiency will be:

$$\frac{98^{10}}{100^9} = 81.7\%$$

The effective torque then becomes:

$$\frac{\text{Actual Torque}}{\text{Efficiency}} = \frac{81}{0.817} = 99\text{Nm}$$

For sprockets with a pitch circle diameter of 140mm, the pull in the chain will be:

$$\frac{2000 \times Md}{d_1} = \frac{2000 \times 99}{140} = 1414 \text{ N}$$

The friction force for a friction coefficient of 0.25 is 35000 x 0.25 = 8750 N

The corresponding torque is equal to:

$$F \times d (\text{force} \times \text{distance}) = 8750 \times \frac{0.15}{2} = 656\text{Nm}$$

Note: Where d = radius of shaft
The total drive torque is 656 + 81 = 737 Nm

The effective torque is therefore:

$$\frac{737}{0.817} = 902\text{Nm}$$

The pull in the chain then becomes:

$$\frac{2000 \times Md}{d_1} = \frac{2000 \times 902}{140} = 12886\text{N}$$

Per drive we can now evaluate chain ISO 16B-1 or Renold Chain 110088 running with two sprockets with 17 teeth and a pitch circle diameter of 138mm.

In normal use:

The safety factor

$$\frac{\text{Axial Breaking force}}{\text{Working load}} = \frac{67000}{1414} = 47.4$$

Bearing pressure

$$\frac{\text{Working load}}{\text{Bearing area}} = \frac{1414}{207} = 6.83\text{N/mm}^2$$

When slipping they are:

The safety factor

$$\frac{\text{Axial Breaking Force}}{\text{Pull in Chain}} = \frac{67000}{12886} = 5.2$$

Bearing pressure

$$\frac{\text{Chain Pull}}{\text{Bearing Area}} = \frac{12886}{207} = 62.26\text{N/mm}^2$$

The linear speed of the chain is:

$$\frac{\text{stack speed} \times d_1}{\text{roller dia}} \left(\frac{1}{60} \right) = \frac{15 \times 0.138}{0.15 \times 60} = 0.23 \text{ m/sec}$$

Note: Where d1 = PCD of sprocket in metres

For each group of 10 rollers the power is: $\frac{F \cdot V}{1000}$

Under normal working conditions

$$\frac{\text{Working load} \times \text{linear speed}}{1000} = \frac{1414 \times 0.23}{1000} = 0.33 \text{ kW}$$

$$\frac{\text{Chain pull} \times \text{linear speed}}{1000} = \frac{12886 \times 0.23}{1000} = 2.96 \text{ kW}$$

When the rollers are slipping

- Taking the efficiency of the gear unit into account and adding a factor of 25% to this total power, 3.7kW will be necessary.

NOTE - At higher linear speeds, we should also take into account other additional factors such as the moment of inertia of the rollers and the power needed to accelerate the various components of the system.

Renold Chain Designer Guide

Shafts in Parallel

Drives of this type will only be used when:

- There is a steady load, preferably divided evenly over the sprocket system.
- At linear speeds not higher than 1.5 m/sec.
- It is driven in one direction only.

The efficiency of this driving method is higher than for the series drive because there is reduced tooth contact.

Every drive needs special attention with regard to the positioning of the driver sprocket, the jockey and the reversing pinions.

The layout of the sprockets, the support and the guidance of the chain determine to a large extent, the service life of the chain.

The chain in most cases is quite long and a good grip on the driver sprocket is only possible when a degree of pre-tensioning is applied. This should never exceed half the normal pulling load of the application.

The method of selection is the same as for that detailed under SHAFTS IN SERIES.

Drives mounted as in figure 2 have an efficiency under normal conditions of:

- 94% with 5 rollers
- 89% with 10 rollers
- 84% with 15 rollers
- 79% with 20 rollers
- 75% with 25 rollers

Figure 1



Figure 2

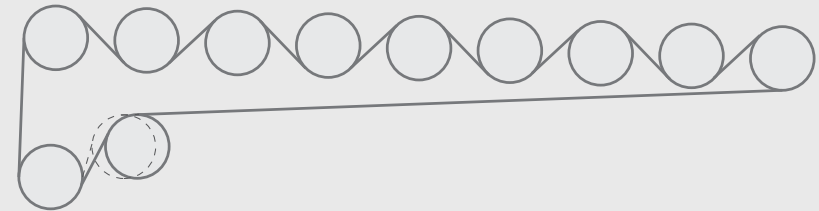

Safety Warnings

Connecting Links

No 11 or No 26 joints (slip fit) should not be used where high speed or arduous conditions are encountered. In these or equivalent circumstances where safety is essential, a riveting link No 107 (interference fit) must be used.

Wherever possible, drives should have sufficient overall adjustment to ensure the use of an even number of pitches throughout the useful life of the chain. A cranked link joint (No 12 or No 30) should only be used as a last resource and restricted to light duty, non-critical applications.

Chain Maintenance

The following precautions must be taken before disconnecting and removing a chain from a drive prior to replacement, repair or length alteration.

1. Always isolate the power source from the drive or equipment.
2. Always wear safety glasses.

3. Always wear appropriate protective clothing, hats, gloves and safety shoes, as warranted by the circumstances.
4. Always ensure tools are in good working condition and used in the proper manner.
5. Always loosen tensioning devices.
6. Always support the chain to avoid sudden unexpected movement of chain or components.
7. Never attempt to disconnect or reconnect a chain unless the method of safe working is fully understood.
8. Make sure correct replacement parts are available before disconnecting the chain.
9. Always ensure that directions for correct use of any tools is followed.
10. Never re-use individual components.
11. Never re-use a damaged chain or chain part.
12. On light duty drives where a spring clip (No 26) is used, always ensure that the clip is fitted correctly in relation to direction of travel.

Renold Roller Chain

ISO 606

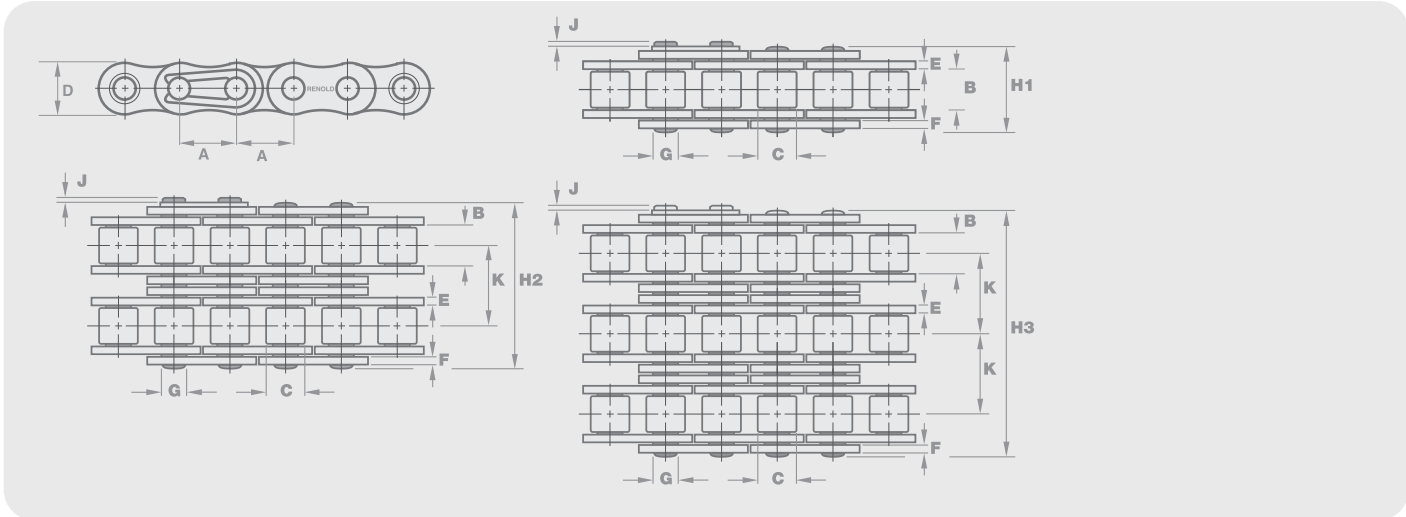

| Chain Ref. | Technical Details (mm) | | | | | | | | | | | | | | | Weight |
|------------|------------------------|------------|--------------|--------------|--------------|-------------------|-------------------|-----------|------------|----------------------|------------------|-------------|-------------|-----------------|-----------------------------------|--------|
| ISO Ref. | Pitch (inch) | Pitch (mm) | Inside Width | Roller Diam. | Plate Height | Plate Width Inner | Plate Width Outer | Pin Diam. | Pin Length | Conn. Link Extension | Transverse Pitch | Chain Track | Chain Track | Bearing Area | ISO606 Tensile Strength (Newtons) | Weight |
| | | | MIN | MAX | MAX | MAX | MAX | MAX | MAX | MAX | MAX | MAX | MAX | mm ² | MIN | kg/m |

European (BS) Standard - Simplex

| | A | A | B | C | D | E | F | G | H | J | K | L | M | | | |
|-------|-------|--------|-------|-------|-------|------|------|-------|------|-----|---|------|------|------|--------|-------|
| 05B-1 | 0.315 | 8.000 | 3.00 | 5.00 | 7.11 | 0.76 | 0.76 | 2.31 | 8.6 | 1.5 | - | 8.1 | 4.7 | 11 | 4400 | 0.18 |
| 06B-1 | 0.375 | 9.525 | 5.72 | 6.35 | 8.20 | 1.29 | 1.04 | 3.28 | 12.5 | 1.3 | - | 11.1 | 7.4 | 28 | 8900 | 0.39 |
| 08B-1 | 0.500 | 12.700 | 7.75 | 8.51 | 11.70 | 1.55 | 1.55 | 4.45 | 16.5 | 2.0 | - | 13.6 | 9.4 | 50 | 17800 | 0.70 |
| 10B-1 | 0.625 | 15.875 | 9.65 | 10.16 | 14.60 | 1.55 | 1.55 | 5.08 | 18.8 | 2.5 | - | 14.8 | 10.3 | 68 | 22200 | 0.96 |
| 12B-1 | 0.750 | 19.050 | 11.68 | 12.07 | 16.00 | 1.81 | 1.81 | 5.72 | 21.9 | 2.6 | - | 17.6 | 12.5 | 89 | 28900 | 1.22 |
| 16B-1 | 1.000 | 25.400 | 17.02 | 15.88 | 21.08 | 4.12 | 3.10 | 8.28 | 34.9 | 2.2 | - | 25.8 | 19.9 | 207 | 60000 | 2.80 |
| 20B-1 | 1.250 | 31.750 | 19.56 | 19.05 | 26.42 | 4.62 | 3.61 | 10.19 | 39.8 | 2.7 | - | 30.5 | 23.8 | 290 | 95000 | 3.85 |
| 24B-1 | 1.500 | 38.100 | 25.40 | 25.40 | 33.40 | 6.10 | 5.08 | 14.63 | 52.6 | 6.8 | - | 36.6 | 29.4 | 548 | 160000 | 7.45 |
| 28B-1 | 1.750 | 44.450 | 30.99 | 27.94 | 37.08 | 7.62 | 6.35 | 15.90 | 64.2 | 6.8 | - | 44.0 | 35.8 | 735 | 200000 | 9.35 |
| 32B-1 | 2.000 | 50.800 | 30.99 | 29.21 | 42.29 | 7.11 | 6.35 | 17.81 | 63.4 | 8.0 | - | 45.8 | 37.1 | 806 | 250000 | 10.10 |
| 40B-1 | 2.500 | 63.500 | 39.30 | 39.37 | 52.96 | 8.13 | 8.13 | 22.89 | 78.2 | 9.5 | - | 56.7 | 45.4 | 1271 | 355000 | 16.50 |

European (BS) Standard - Duplex

| | A | A | B | C | D | E | F | G | H | J | K | L | M | | | |
|-------|-------|--------|-------|-------|-------|------|------|-------|-------|-----|-------|------|------|------|--------|-------|
| 05B-2 | 0.315 | 8.000 | 3.00 | 5.00 | 7.11 | 0.76 | 0.76 | 2.31 | 14.3 | 1.5 | 5.64 | 11.3 | 7.9 | 22 | 7800 | 0.36 |
| 06B-2 | 0.375 | 9.525 | 5.72 | 6.35 | 8.20 | 1.29 | 1.04 | 3.28 | 23.0 | 1.3 | 10.24 | 16.7 | 13.1 | 56 | 16900 | 0.78 |
| 08B-2 | 0.500 | 12.700 | 7.75 | 8.51 | 11.70 | 1.55 | 1.55 | 4.45 | 30.4 | 2.0 | 13.92 | 21.3 | 17.1 | 100 | 31100 | 1.38 |
| 10B-2 | 0.625 | 15.875 | 9.65 | 10.16 | 14.60 | 1.55 | 1.55 | 5.08 | 35.4 | 2.5 | 16.59 | 23.9 | 19.4 | 134 | 44500 | 1.69 |
| 12B-2 | 0.750 | 19.050 | 11.68 | 12.07 | 16.00 | 1.81 | 1.81 | 5.72 | 41.4 | 2.6 | 19.46 | 28.3 | 23.2 | 178 | 57800 | 2.42 |
| 16B-2 | 1.000 | 25.400 | 17.02 | 15.88 | 21.08 | 4.12 | 3.10 | 8.28 | 66.8 | 2.2 | 31.88 | 43.3 | 37.4 | 413 | 106000 | 5.50 |
| 20B-2 | 1.250 | 31.750 | 19.56 | 19.05 | 26.42 | 4.62 | 3.61 | 10.19 | 76.7 | 2.7 | 36.45 | 50.6 | 43.8 | 587 | 170000 | 7.80 |
| 24B-2 | 1.500 | 38.100 | 25.40 | 25.40 | 33.40 | 6.10 | 5.08 | 14.63 | 101.3 | 6.8 | 48.36 | 63.3 | 56.0 | 1103 | 280000 | 14.80 |
| 28B-2 | 1.750 | 44.450 | 30.99 | 27.94 | 37.08 | 7.62 | 6.35 | 15.90 | 123.7 | 6.8 | 59.56 | 76.7 | 68.6 | 1471 | 360000 | 18.60 |
| 32B-2 | 2.000 | 50.800 | 30.99 | 29.21 | 42.29 | 7.11 | 6.35 | 17.81 | 122.0 | 8.0 | 58.55 | 78.0 | 69.3 | 1613 | 450000 | 20.10 |
| 40B-2 | 2.500 | 63.500 | 39.30 | 39.37 | 52.96 | 8.13 | 8.13 | 22.89 | 150.5 | 9.5 | 72.29 | 96.4 | 85.2 | 2542 | 630000 | 16.50 |

European (BS) Standard - Triplex

| | A | A | B | C | D | E | F | G | H | J | K | L | M | | | |
|-------|-------|--------|-------|-------|-------|------|------|-------|-------|-----|-------|-------|-------|---------|--------|-------|
| 05B-3 | 0.315 | 8.000 | 3.00 | 5.00 | 7.11 | 0.76 | 0.76 | 2.31 | 19.9 | 1.5 | 5.64 | 14.4 | 11.0 | 33.00 | 11100 | 0.54 |
| 06B-3 | 0.375 | 9.525 | 5.72 | 6.35 | 8.20 | 1.29 | 1.04 | 3.28 | 33.3 | 1.3 | 10.24 | 22.3 | 18.7 | 84.00 | 24900 | 1.11 |
| 08B-3 | 0.500 | 12.700 | 7.75 | 8.51 | 11.70 | 1.55 | 1.55 | 4.45 | 44.3 | 2.0 | 13.92 | 29.0 | 24.7 | 150.00 | 44500 | 2.06 |
| 10B-3 | 0.625 | 15.875 | 9.65 | 10.16 | 14.60 | 1.55 | 1.55 | 5.08 | 52.0 | 2.5 | 16.59 | 33.6 | 29.0 | 202.00 | 66700 | 2.54 |
| 12B-3 | 0.750 | 19.050 | 11.68 | 12.07 | 16.00 | 1.81 | 1.81 | 5.72 | 60.9 | 2.6 | 19.46 | 39.0 | 34.0 | 267.00 | 86700 | 3.59 |
| 16B-3 | 1.000 | 25.400 | 17.02 | 15.88 | 21.08 | 4.12 | 3.10 | 8.28 | 98.6 | 2.2 | 31.88 | 61.0 | 55.0 | 619.00 | 160000 | 8.15 |
| 20B-3 | 1.250 | 31.750 | 19.56 | 19.05 | 26.42 | 4.62 | 3.61 | 10.19 | 113.2 | 2.7 | 36.45 | 71.0 | 63.9 | 885.00 | 250000 | 11.65 |
| 24B-3 | 1.500 | 38.100 | 25.40 | 25.40 | 33.40 | 6.10 | 5.08 | 14.63 | 149.7 | 6.8 | 48.36 | 90.0 | 83.0 | 1658.00 | 425000 | 22.25 |
| 28B-3 | 1.750 | 44.450 | 30.99 | 27.94 | 37.08 | 7.62 | 6.35 | 15.90 | 183.3 | 6.8 | 59.56 | 110.0 | 102.0 | 2206.00 | 530000 | 28.00 |
| 32B-3 | 2.000 | 50.800 | 30.99 | 29.21 | 42.29 | 7.11 | 6.35 | 17.81 | 180.5 | 8.0 | 58.55 | 110.0 | 102.0 | 2419.00 | 670000 | 30.00 |
| 40B-3 | 2.500 | 63.500 | 39.30 | 39.37 | 52.96 | 8.13 | 8.13 | 22.89 | 222.8 | 9.5 | 72.29 | 136.0 | 125.0 | 3813.00 | 950000 | 48.90 |

Renold Roller Chain

ISO 606

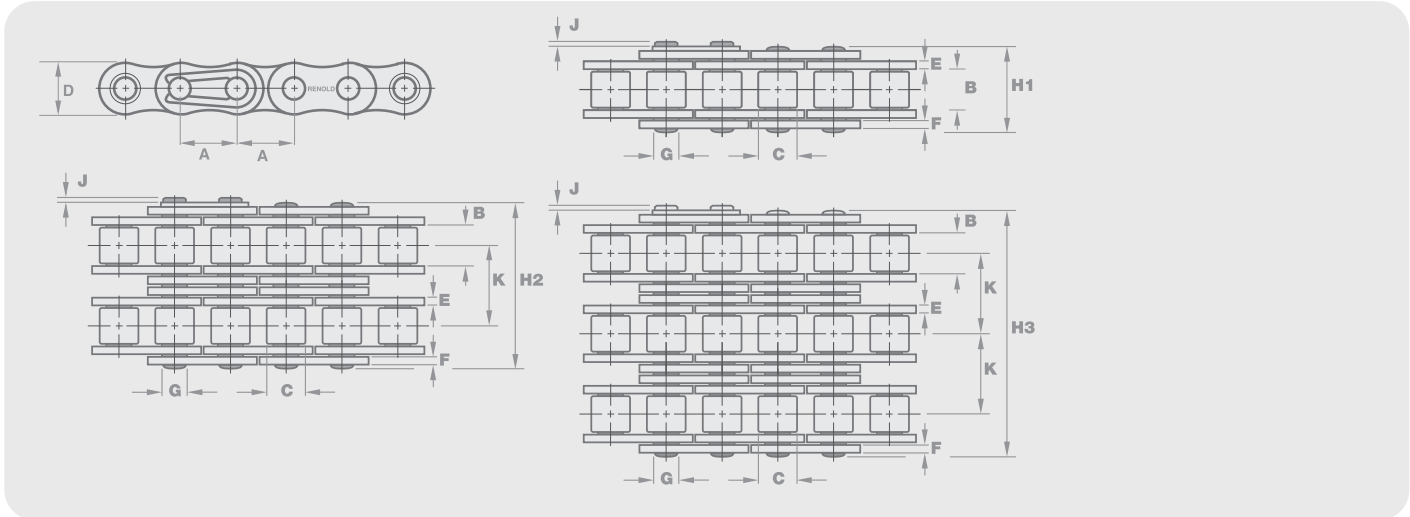

| Chain Ref. | Technical Details (mm) | | | | | | | | | | | | | | | | |
|------------|------------------------|------------|--------------|--------------|--------------|-------------------|-------------------|-----------|------------|----------------------|------------------|-------------|-------------|--------------|-----------------------------------|--------|------|
| ISO Ref. | Pitch (inch) | Pitch (mm) | Inside Width | Roller Diam. | Plate Height | Plate Width Inner | Plate Width Outer | Pin Diam. | Pin Length | Conn. Link Extension | Transverse Pitch | Chain Track | Chain Track | Bearing Area | ISO606 Tensile Strength (Newtons) | Weight | |
| | | | MIN | MAX | MAX | MAX | MAX | MAX | MAX | MAX | MAX | MAX | MAX | MAX | mm ² NOM | MIN | kg/m |

ANSI Standard - Simplex

| | A | A | B | C | D | E | F | G | H | J | K | L | M | | | |
|-------------------|-------|--------|-------|-------|-------|------|------|-------|------|-----|---|------|------|------|--------|-------|
| 25-1 [◇] | 0.250 | 6.350 | 3.10 | 3.30 | 5.90 | 0.76 | 0.76 | 2.30 | 7.9 | 1.2 | - | 5.6 | 4.7 | 11 | 3500 | 0.12 |
| 35-1 [◇] | 0.375 | 9.525 | 4.68 | 5.08 | 8.60 | 1.29 | 1.29 | 3.59 | 12.0 | 1.7 | - | 12.2 | 8.5 | 26 | 7900 | 0.35 |
| 40 | 0.500 | 12.700 | 7.85 | 7.92 | 11.20 | 1.55 | 1.55 | 3.97 | 16.4 | 2.1 | - | 14.1 | 10.0 | 44 | 13900 | 0.60 |
| 50-1 | 0.625 | 15.875 | 9.40 | 10.16 | 14.60 | 2.04 | 2.04 | 5.08 | 20.4 | 2.7 | - | 16.5 | 12.0 | 70 | 21800 | 1.00 |
| 60-1 | 0.750 | 19.050 | 12.57 | 11.91 | 17.50 | 2.45 | 2.45 | 5.94 | 25.3 | 2.6 | - | 19.9 | 14.8 | 105 | 31300 | 1.47 |
| 80-1 | 1.000 | 25.400 | 15.75 | 15.88 | 24.13 | 3.25 | 3.25 | 7.94 | 32.7 | 3.0 | - | 24.4 | 18.4 | 177 | 55600 | 2.80 |
| 100-1 | 1.250 | 31.750 | 18.90 | 19.05 | 30.17 | 4.06 | 4.06 | 9.54 | 39.7 | 4.2 | - | 29.3 | 22.6 | 258 | 87000 | 4.20 |
| 120-1 | 1.500 | 38.100 | 25.23 | 22.23 | 36.20 | 4.80 | 4.80 | 11.11 | 49.3 | 5.3 | - | 35.2 | 27.9 | 390 | 125000 | 5.70 |
| 140-1 | 1.750 | 44.450 | 25.23 | 25.40 | 42.23 | 5.61 | 5.61 | 12.71 | 52.9 | 5.2 | - | 38.3 | 30.2 | 468 | 170000 | 7.80 |
| 160-1 | 2.000 | 50.800 | 31.55 | 28.58 | 48.26 | 6.35 | 6.35 | 14.29 | 63.1 | 6.5 | - | 44.7 | 36.0 | 639 | 223000 | 10.40 |
| 200-1 | 2.500 | 63.500 | 37.85 | 39.67 | 60.33 | 8.13 | 8.13 | 19.85 | 76.9 | 9.0 | - | 55.4 | 44.2 | 1077 | 347000 | 17.30 |

ANSI Standard - Duplex

| | A | A | B | C | D | E | F | G | H | J | K | L | M | | | |
|-------------------|-------|--------|-------|-------|-------|------|------|-------|-------|-----|-------|------|------|------|--------|-------|
| 35-2 [◇] | 0.375 | 9.525 | 4.68 | 5.08 | 8.60 | 1.29 | 1.29 | 3.59 | 22.2 | 1.7 | 10.13 | 17.7 | 14.1 | 53 | 15800 | 0.62 |
| 40-2 | 0.500 | 12.700 | 7.85 | 7.92 | 11.20 | 1.55 | 1.55 | 3.97 | 30.8 | 2.1 | 14.38 | 22.0 | 17.7 | 88 | 27800 | 1.20 |
| 50-2 | 0.625 | 15.875 | 9.40 | 10.16 | 14.60 | 2.04 | 2.04 | 5.08 | 38.4 | 2.7 | 18.11 | 26.5 | 22.0 | 141 | 43600 | 1.98 |
| 60-2 | 0.750 | 19.050 | 12.57 | 11.91 | 17.50 | 2.45 | 2.45 | 5.94 | 48.1 | 2.6 | 22.78 | 32.5 | 27.4 | 210 | 62600 | 2.91 |
| 80-2 | 1.000 | 25.400 | 15.75 | 15.88 | 24.13 | 3.25 | 3.25 | 7.94 | 61.9 | 3.0 | 29.29 | 40.4 | 34.5 | 355 | 111200 | 5.50 |
| 100-2 | 1.250 | 31.750 | 18.90 | 19.05 | 30.17 | 4.06 | 4.06 | 9.54 | 75.4 | 4.2 | 35.76 | 49.1 | 42.4 | 516 | 174000 | 8.40 |
| 120-2 | 1.500 | 38.100 | 25.23 | 22.23 | 36.20 | 4.80 | 4.80 | 11.11 | 94.7 | 5.3 | 45.44 | 60.2 | 53.0 | 781 | 250000 | 11.00 |
| 140-2 | 1.750 | 44.450 | 25.23 | 25.40 | 42.23 | 5.61 | 5.61 | 12.71 | 101.8 | 5.2 | 48.87 | 65.1 | 57.0 | 935 | 340000 | 15.50 |
| 160-2 | 2.000 | 50.800 | 31.55 | 28.58 | 48.26 | 6.35 | 6.35 | 14.29 | 121.6 | 6.5 | 58.55 | 77.0 | 68.3 | 1278 | 446000 | 20.60 |
| 200-2 | 2.500 | 63.500 | 37.85 | 39.67 | 60.33 | 8.13 | 8.13 | 19.85 | 148.5 | 9.0 | 71.55 | 95.0 | 83.6 | 2155 | 694000 | 34.40 |

ANSI Standard - Triplex

| | A | A | B | C | D | E | F | G | H | J | K | L | M | | | |
|-------------------|-------|--------|-------|-------|-------|------|------|-------|-------|-----|-------|-------|-------|------|---------|-------|
| 35-3 [◇] | 0.375 | 9.525 | 4.68 | 5.08 | 8.60 | 1.29 | 1.29 | 3.59 | 32.2 | 1.7 | 10.13 | 22.4 | 18.7 | 79 | 23700 | 0.93 |
| 40-3 | 0.500 | 12.700 | 7.85 | 7.92 | 11.20 | 1.55 | 1.55 | 3.97 | 45.1 | 2.1 | 14.38 | 29.7 | 25.4 | 132 | 41700 | 1.80 |
| 50-3 | 0.625 | 15.875 | 9.40 | 10.16 | 14.60 | 2.04 | 2.04 | 5.08 | 56.5 | 2.7 | 18.11 | 36.4 | 31.9 | 211 | 65400 | 2.96 |
| 60-3 | 0.750 | 19.050 | 12.57 | 11.91 | 17.50 | 2.45 | 2.45 | 5.94 | 70.9 | 2.6 | 22.78 | 45.0 | 40.0 | 315 | 93900 | 4.38 |
| 80-3 | 1.000 | 25.400 | 15.75 | 15.88 | 24.13 | 3.25 | 3.25 | 7.94 | 91.2 | 3.0 | 29.29 | 56.5 | 50.6 | 532 | 166800 | 8.30 |
| 100-3 | 1.250 | 31.750 | 18.90 | 19.05 | 30.17 | 4.06 | 4.06 | 9.54 | 111.2 | 4.2 | 35.76 | 68.9 | 62.2 | 774 | 261000 | 12.60 |
| 120-3 | 1.500 | 38.100 | 25.23 | 22.23 | 36.20 | 4.80 | 4.80 | 11.11 | 140.2 | 5.3 | 45.44 | 85.2 | 78.0 | 1171 | 375000 | 16.70 |
| 140-3 | 1.750 | 44.450 | 25.23 | 25.40 | 42.23 | 5.61 | 5.61 | 12.71 | 150.7 | 5.2 | 48.87 | 92.0 | 83.8 | 1403 | 510000 | 23.10 |
| 160-3 | 2.000 | 50.800 | 31.55 | 28.58 | 48.26 | 6.35 | 6.35 | 14.29 | 180.2 | 6.5 | 58.55 | 110.0 | 101.0 | 1916 | 669000 | 31.00 |
| 200-3 | 2.500 | 63.500 | 37.85 | 39.67 | 60.33 | 8.13 | 8.13 | 19.85 | 229.0 | 9.0 | 71.55 | 132.0 | 121.0 | 3232 | 1041000 | 51.20 |

[◇] Bush Chain. Detachable Cottered Chain available on request.

Safety warning

Outer Link: for high speed drives or drives operating in arduous conditions a properly riveted outer link (No 107) must always be used for optimum security, in preference to any other form of chain joint. The use of other connectors and cranked links (No 12 and No 30) must always be restricted to light duty, non-critical applications, in drives where an odd number of pitches is absolutely unavoidable. Wherever possible, drives should have sufficient overall adjustment to ensure the use of an even number of pitches throughout the useful life of the chain. A cranked link joint should only be used as a last resort.

Health and Safety at work

In the interests of safety, customers are reminded that when purchasing any technical product for use at work (or otherwise), any additional or up-to-date information and guidance, which it has not been possible to include in the publication, should be obtained by you from your local sales office in relation to the suitability and the safe and proper use of the product. All relevant information and guidance must be passed on by you to the person engaged in, or likely to be affected by or responsible for the use of the product.

Chain performance

The performance levels and tolerances of our product stated in this catalogue (including without limitation, serviceability, wear life, resistance to fatigue, corrosion protection) have been verified in a programme of testing and quality control in accordance with Renold, independent and/or international standard recommendations.

No representations or warranties are given that our product shall meet the stated performance levels or tolerances for any given application outside the performance levels and tolerances for the product's own specific application and environment.

Guidance notes

Whilst all reasonable care in compiling the information contained in this catalogue is taken, no responsibility is accepted for errors. All information contained in this catalogue is subject to change without notice.

Illustrations - The illustrations used in this catalogue represent the type of product described but the goods supplied may vary in some detail from those illustrated.

Specifications - The right is reserved to make modifications to the product to meet manufacturing conditions and/or developments (for example in design or materials).

Renold - Product can be supplied by Renold companies or representatives around the world on the standard terms and conditions of sale of the company or representative from which the product is purchased.

Copyright - Copyright Renold Power Transmission Limited 2010. All rights reserved.

Nothing contained in this publication shall constitute a part of any contract, express or implied.

Australia**Melbourne (Victoria)**

Tel: + 61 (0) 3 9262 3333
Fax: + 61 (0) 3 9561 8561
e-mail: melsmg@renold.com.au

*also at: Sydney, Brisbane, Adelaide, Perth,
Newcastle, Wollongong, Townsville*

Austria**Vienna**

Tel: + 43 (0) 1 330 3484
Fax: + 43 (0) 1 330 3484-5
e-mail: office@renold.at

*also at: Budapest (Hungary),
Zlin (Czech Republic)*

Belgium**Gent**

Tel: + 32 (0) 9 242 95 50
Fax: + 32 (0) 9 242 95 59
e-mail: info@renold.be

Canada**Montreal (Quebec)**

Tel: + 1 514 367 1764
Fax: + 1 514 367 4993
e-mail: inquiry@renoldcanada.com

China**Shanghai**

Tel: + 21 5046 2696
Fax: + 21 5046 2695
e-mail: sales@renold.cn

Czech Republic**Zlin**

Tel: + 420 606 727 811
Fax: + 420 577 240 324
e-mail: jaroslav.edlinger@renold.com

France**Seclin**

Tel: + 33 (0) 320 16 29 29
Fax: + 33 (0) 320 16 29 00
e-mail: contact@brampton-renold.com

Germany**Einbeck**

Tel: + 49 (0) 5562 810
Fax: + 49 (0) 5562 81130
e-mail: info@renold.de

India**Coimbatore**

Tel: +91 - 422 4226800
Fax: +91 - 422 2532358
e-mail: marketing@renold.in

Malaysia**Selangor Darul Ehsan**

Tel: + 60 3-5122 7880
Fax: + 60 3-5122 7881
e-mail: malaysia@renold.com

also at: Johor Bharu, Ipoh, Penang

Netherlands**Amsterdam**

Tel: + 31 (0) 20 6146661
Fax: + 31 (0) 20 6146391
e-mail: info@renold.nl

New Zealand**Auckland**

Tel: + 64 9828 5018
Fax: + 64 9828 5019
e-mail: aksales@renold.co.nz

also at: Christchurch

Philippines**Paranaque City**

Tel: + 63 2 829 6086
Fax: + 63 2 826 5211

Poland

Tel: + 48 663 842 487
e-mail: info@renold.pl

Romania**Motca**

Tel: + 4 0726 69 56 52
Fax: + 4 0232 76 56 52
e-mail: renold.romania@yahoo.co.uk

Russia**Moscow**

Tel: + 7 495 645 2250
Fax: + 7 495 645 2251
e-mail: info@renold.ru

Scandinavia**Hvidovre (Copenhagen)**

Tel: + 45 43 45 26 11
Fax: + 45 43 45 65 92
e-mail: infor@renold.com

Singapore

Tel: + 65 6760 2422
Fax: + 65 6760 1507
e-mail: sales@renold.sg

South Africa**Benoni (Johannesburg)**

Tel: + 27 11 747 9500
Fax: + 27 11 747 9505
e-mail: sales@renold.co.za

*also at: Richards Bay,
Port Elizabeth, Cape Town*

Spain**Gavá (Barcelona)**

Tel: + 34 93 638 9641
Fax: + 34 93 638 0737
e-mail: spain@renold.com

Switzerland**Dübendorf (Zürich)**

Tel: + 41 (0) 44 824 8484
Fax: + 41 (0) 44 824 8411
e-mail: duebendorf@renold.com

also at: Crissier (Lausanne)

UK**Burton upon Trent**

Tel: + 44 (0) 1283 512940
Fax: + 44 (0) 1283 512628
e-mail: ukchain@renold.com

USA**Morristown TN**

Tel: + 1 800 251 9012
Fax: + 1 423 581 2399
e-mail: sales@renoldjeffrey.com

*For other country distributors please consult
www.renold.com.*

*Whilst all reasonable care is taken in compiling the
information contained in this brochure, no
responsibility is accepted for printing errors.*

*All information contained in this brochure is
subject to change after the date of publication.*

© Renold Power Transmission 2010.
Ref: REN12 / ENG / 10.10

RENOLD
Superior Chain Technology